

Single Pack SC12/12G 220-240V 50Hz CSIR

Single pack code number: **195B3255**

Position	Title	Code	Amount
1	Compressor SC12/12G	104G8280	1
2	Starting relay	117U6003	2
3	Starting capacitor (80 μ F 220V, 6.3mm)	117U5017	2
4	Cord relief	103N1004	2
5	Cover	103N2009	2
6	Bolt joint for one compressor M6 \varnothing 16mm	118-1917	2

Secop GmbH • Lise-Meitner-Straße 29 • 24941 Flensburg, Germany • Tel: +49 461 4941 0 • www.secop.com

Secop accepts no responsibility for possible errors in catalogs, brochures, and other printed material. Secop reserves the right to alter its products without notice. This also applies to products already on order provided that such alterations can be made without subsequent changes being necessary to specifications already agreed. All trademarks in this material are the property of the respective companies. Secop and the Secop logotype are trademarks of Secop GmbH. All rights reserved.

Model

Designation	SC12/12G	220-240V/50Hz 1~	Sales code:	104G8280
-------------	-----------------	------------------	-------------	-----------------

Compressor design

Oil type	Polyolester	Refrigerant(s)	R134a
Oil viscosity	22cST	Displacement	25,74cm ³ / 1,57cu.in
Oil quantity	1238cm ³ / 41,9fl.oz	Compressors on pallet	18
Refr. charge - tech. limit	2200g / 77,6oz		
Free gas volume comp.	3020cm ³ / 102,1fl.oz		
Weight	28kg / 61,7lbs		
Motor protection	1# internal		
Winding resistance main	6,9Ω (at 25°C)		
Winding resistance aux	11Ω (at 25°C)		
Max. winding temp.	125°C / 257°F		
Max. discharge temp.	135°C / 275°F		



General - Configurations with SC12/12G

	Conf. 1
Motorconfiguration	CSIR
Power supply (nominal)	220-240V/50Hz
Number of phases	1
Voltage range	187-254V
Approvals	CCC, VDE
Starting torque	HST
Note	- / -

Applications with SC12/12G

	Conf. 1
Refrigerant	R134a
Application	LBP+MBP+HBP
System cooling	fan 3m/s
Hot gas defrost	OK
Long interval pull down	OK

Electrical data - Configurations with SC12/12G

	Conf. 1
Starting device type	relay
Run capacitor	- / -
Start capacitor	80μF
LRA (locked rotor amps / 4s)	2x 23,4A
RLA (rated load amps / 1s)	2x 4,3A
Cut in current	2x 23,4A

Model

Designation

SC12/12G

220-240V/50Hz 1~

Sales code:

104G8280

Compressor dimensions

Housing	A Height	249mm / 9,8in
	B Height	244mm / 9,61in
	B1	183mm / 7,2in
	B2	100mm / 3,94in

Connectors		Suction	Discharge	Process
		C	E	D
Diameter	[mm]	øi 15,21-15,37	øi 6,11-6,29	øi 6,11-6,29
(i:inside, o:outside)	[in]	øi 0,6-0,61	øi 0,24-0,25	øi 0,24-0,25
Material		steel	copper	copper
Horizontal angle	±2°	0°	37°	37°
Vertical angle	±2°	0°	0°	0°
Position l/h/w	[mm]	0/0/0	0/0/0	0/0/0
	[in]	0/0/0	0/0/0	0/0/0
Straight tube l.	[mm]	10	12	12
	[in]	0,4	0,5	0,5

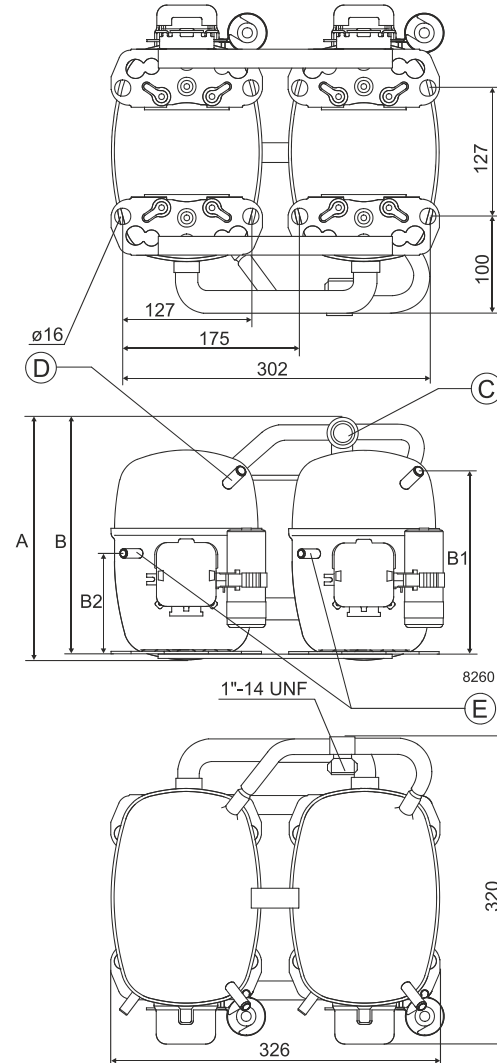

Compressor fixation

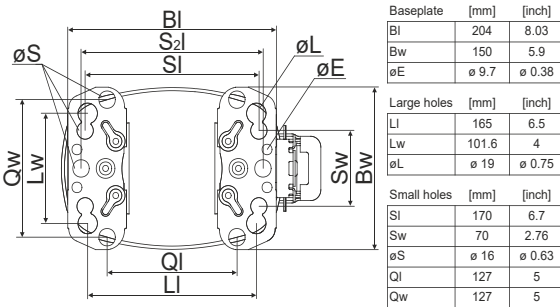

Mounting accessories

	one comp.	multi pack
Bolt joint M6 Ø16mm	118-1917	118-1918
Bolt joint Ø1/4" Ø16mm	118-1946	
Bolt joint Ø1/4" Ø19mm	118-1949	
Snap-on Ø7,3 Ø16mm	118-1947	118-1919

Bolt joint

Snap-on

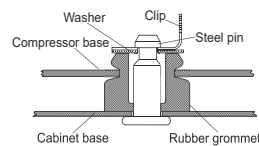
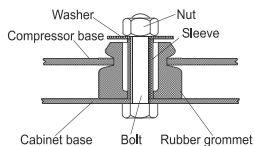

Application notes

Provision for PE Grounding is located at the PE Stamp on the compressor

Twin should be used with a time-delay relay

Model			
Designation	SC12/12G	220-240V/50Hz	Conf. 1
			Sales code: 104G8280

Configuration		Ambient/ machine room temperatures minimum /maximum
Motorconfiguration	CSIR	Ambient temperature range: 10 - 43°C / 50 - 110°F
Power supply (nominal)	220-240V/50Hz 1~	Machine room temperature range: 10 - 48°C / 50 - 119°F
Refrigerant	R134a	Compressor cooling: fan 3m/s
Application	LBP+MBP+HBP	
Voltage range	187-254V	
Starting torque	HST	
Approvals	CCC, VDE,	

Operation Limits

Electrical accessories / wiring diagram

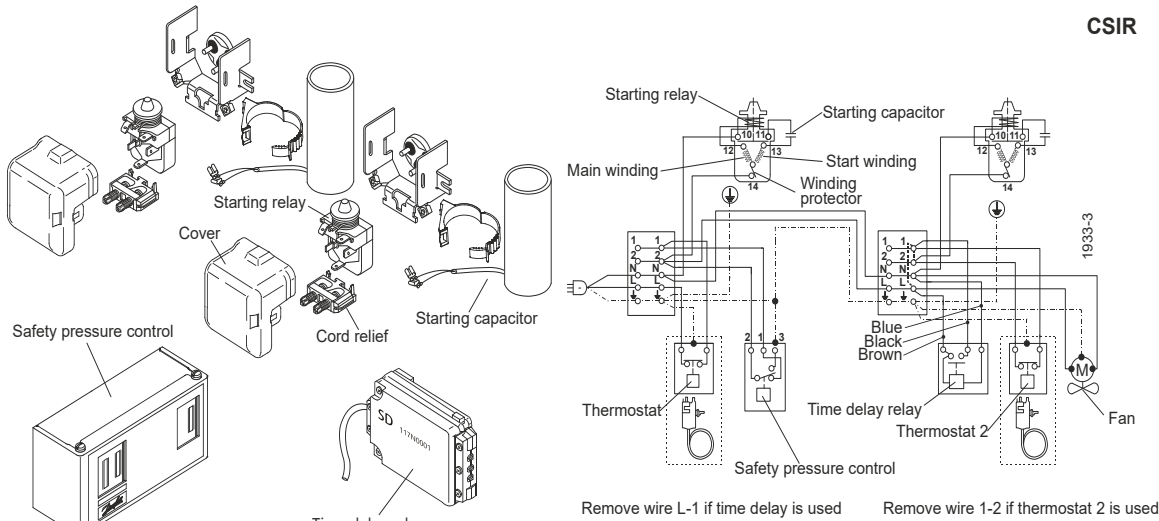

Remove wire L-1 if time delay is used Remove wire 1-2 if thermostat 2 is used

Operation pressure range

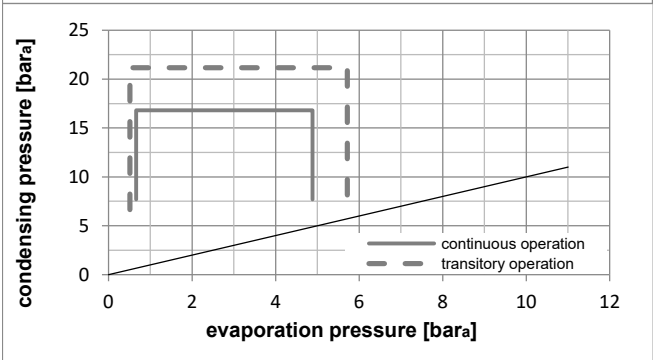
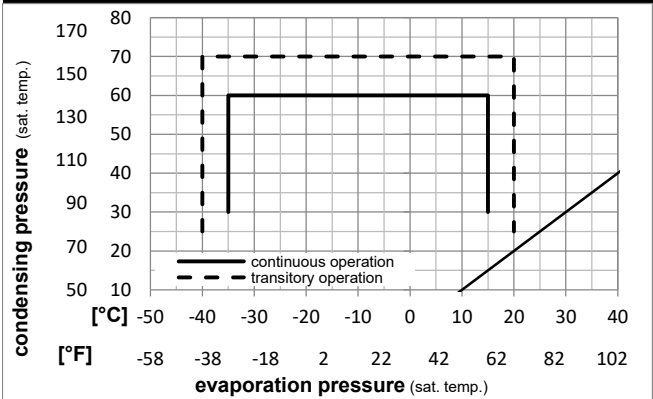

Components

- a2 assy. relay 117U6003
- c start capacitor (80µF) 117U5017
- d cord relief 103N1004
- b plastic cover 103N2009
- . Check valve (to be used with time-delay relay) 020-1014
- . Service valve 12mm 118-7350
- . Solder connector (alternative) 12 mm 104B0584
- . Seal ring for service valve and solder conn. 118-3638

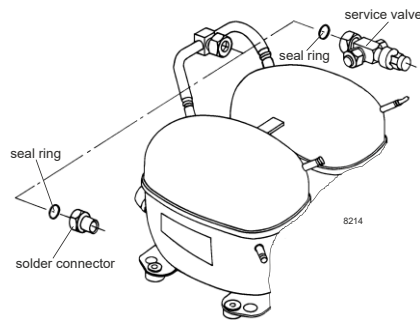

Model

Designation **SC12/12G** **220-240V/50Hz** Conf. 1 Sales code: **104G8280**

Optimization + standard conditions

R134a, 220V/50Hz, CSIR, fan 3m/s, CCC, VDE

		Evaporating pressure (saturation temperature)				Condensing pressure (saturation temperature)						Power consumption			
		Return gas temp.		Liquid temp.		Cooling capacity		COP	EER		Current consumption		Ref. mass flow		
		pe	pc	RGT	Tliq	[W]	[Btu/h]	[kcal/h]	[W/W]	[Btu/W _h]	[kcal/W _h]	P1	I	m	
[°C]	[°F]	[°C]	[°F]	[°C]	[°C]							[W]	[A]	[kg/h]	
-23	-10	54	130	32	90	495,1	1691	426,1	1,03	3,52	0,89	480,7	3,74	9,61	ASHRAE LBP
-7	20	54	130	35	95	1230,0	4201	1058,6	1,60	5,47	1,38	767,8	4,67	26,84	ASHRAE MBP
7,2	45	54	130	35	95	2340,8	7994	2014,5	2,29	7,81	1,97	1023,5	5,67	51,93	ASHRAE HBP
-35	-31	40	104	20	68	246,5	842	212,2	0,75	2,55	0,64	329,9	3,45	5,41	EN12900 LBP
-10	14	45	113	20	68	1094,3	3737	941,8	1,61	5,51	1,39	678,5	4,30	25,62	EN12900 MBP
5	41	50	122	20	68	1989,5	6795	1712,2	2,10	7,16	1,80	949,4	5,34	50,13	EN12900 HBP

Performance tables

R134a, 220V/50Hz, CSIR, fan 3m/s, CCC, VDE

	pe		Cooling capacity			COP	EER	P1			I	m
	[°C]	[°F]	[W]	[Btu/h]	[kcal/h]	[W/W]	[Btu/W _h]	[kcal/W _h]	[W]	[A]	[kg/h]	
[°C / °F]	-35	-31	205,2	701	176,6	0,65	2,21	0,56	317,0	3,38	4,43	
cond. pressure	-25	-13	469,5	1603	404,0	1,03	3,51	0,89	456,2	3,67	10,17	
pc= 45/113	-15	5	871,0	2975	749,6	1,44	4,93	1,24	602,9	4,06	18,99	
return gas temp.	-10	14	1135,3	3877	977,1	1,67	5,71	1,44	678,5	4,30	24,85	
RGT= 32/90	0	32	1815,5	6200	1562,4	2,18	7,44	1,88	833,2	4,85	40,15	
liquid temp	5	41	2241,0	7653	1928,6	2,46	8,39	2,11	911,9	5,16	49,89	
Tliq= 45/113	15	59	3287,1	11226	2828,9	3,07	10,48	2,64	1071,0	5,87	74,46	
[°C / °F]	-35	-31	129,2	441	111,2	0,44	1,49	0,38	295,7	3,25	3,08	
cond. pressure	-25	-13	349,9	1195	301,1	0,77	2,63	0,66	453,5	3,66	8,37	
pc= 55/131	-15	5	696,0	2377	599,0	1,12	3,82	0,96	622,3	4,17	16,76	
return gas temp	-10	14	928,2	3170	798,8	1,31	4,46	1,12	710,2	4,47	22,44	
RGT= 32/90	0	32	1535,1	5243	1321,1	1,72	5,88	1,48	892,2	5,14	37,55	
liquid temp	5	41	1919,6	6556	1652,0	1,95	6,65	1,68	985,9	5,52	47,30	
Tliq= 55/131	15	59	2874,6	9817	2473,9	2,44	8,34	2,10	1177,5	6,35	72,20	

SC Twin Compressors

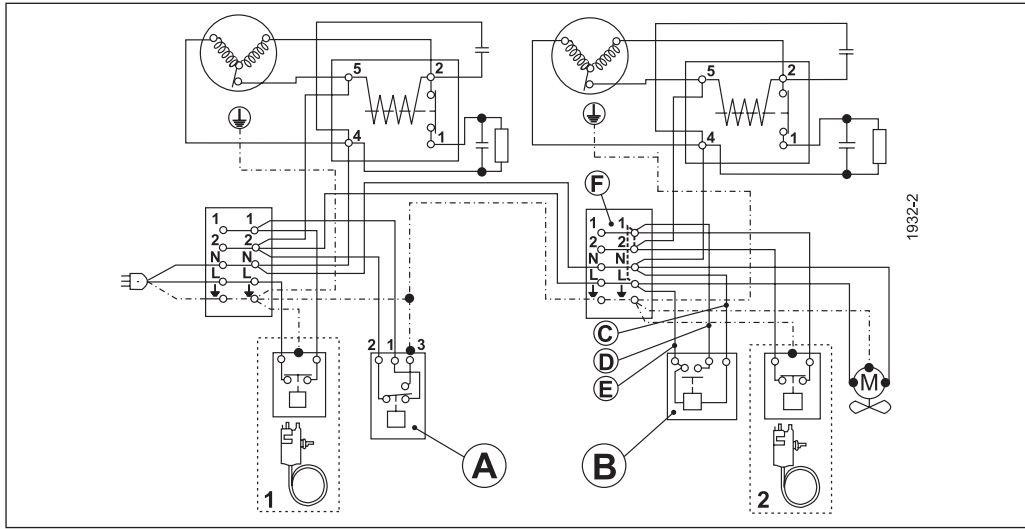
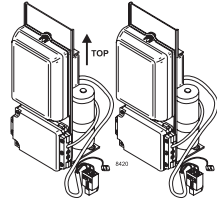
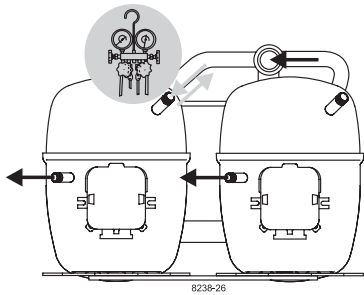

	A	B	C	D	E	F	
ENGLISH	Safety pressure control	Time delay relay	Blue	Black	Brown	Remove wire L-1 if time delay is used	Remove wire 1-2 if thermostat 2 is used
中文	安全压力控制	延时继电器	蓝	黑	棕	若延时继电器使用, 线L-1不使用	若温控器2使用, 线1-2不使用
Русский	Предохранительное реле давления	Реле задержки времени	Синий	Чёрный	Коричневый	Отсоедините провод L-1, если используется реле задержки времени	Отсоедините провод 1-2, если используется термостат 2
DEUTSCH	Sicherheitsdruckschalter	Zeitrelais (verzögernd)	Blau	Schwarz	Braun	Bei Benutzung der Anlaßverzögerung Brücke L-1 entfernen	Bei Benutzung von Thermostat 2 Brücke 1-2 entfernen
FRANÇAIS	Pressostat	Relais de temporisation	Bleu	Noir	Marron	Supprimer la connection L-1 si le relais de temporisation est utilisé	Supprimer la connection 1-2 si thermostat 2 est utilisé
ESPAÑOL	Presostato de seguridad	Relé de retardo	Azul	Negro	Marrón	Quitar cable L-1, si se utiliza un relé de retardo	Quitar cable 1-2, si se utiliza el termostato 2
ITALIANO	Pressostato	Relè di ritardo avviam.	Blu	Nero	Marrone	Eliminare il cavo L-1 se è utilizzato il ritardatore	Eliminare il cavo 1-2 se è utilizzato il termostato 2
NEDERLANDS	Pressostaat	Tijdvertraging-relais	Blauw	Zwart	Bruin	Verwijder draad L-1 indien tijdvertraging wordt toegepast	Verwijder draad 1-2 indien thermostaat wordt toegepast
DANSK	Sikkerhedspressostat	Tidsforsinkelsesrelæ	Blå	Sort	Brun	Ved tidsforsinkelse fjernes ledning L-1	Ved termostat 2 fjernes ledning 1-2
SVENSKA	Säkerhetspressostat	Tidsfördröjningsrelä	Blå	Svart	Brun	Vid anslutning av tidsfördröjningsrelä avlägsnas bygling L-1	Vid anslutning av termostat 2 avlägsnas bygling 1-2

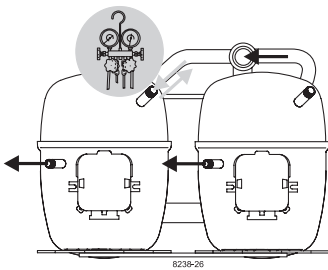

SC Twin Compressors

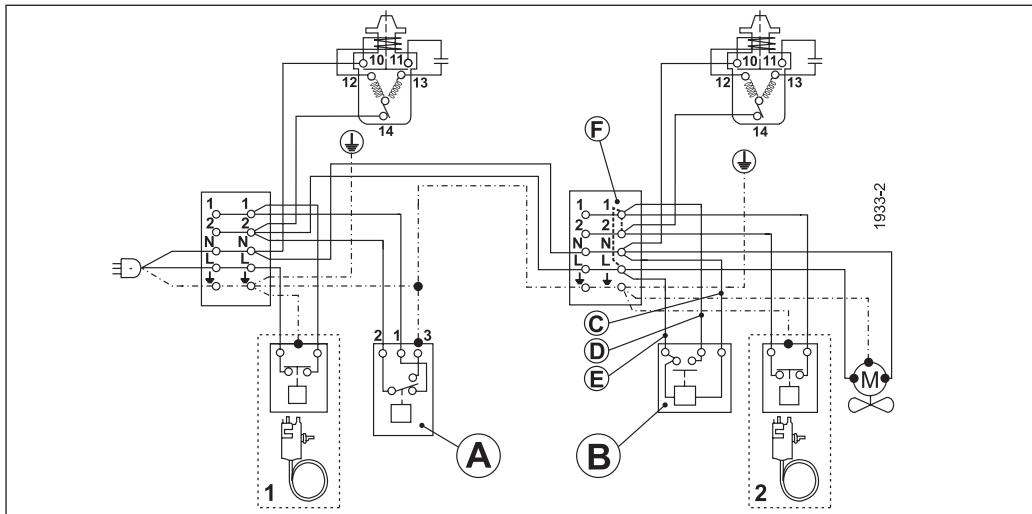
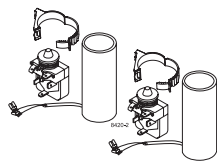

	A	B	C	D	E	F	
ENGLISH	Safety pressure control	Time delay relay	Blue	Black	Brown	Remove wire L-1 if time delay is used	Remove wire 1-2 if thermostat 2 is used
中文	安全压力控制	延时继电器	蓝	黑	棕	若延时继电器使用, 线L-1不使用	若温控器2使用, 线1-2不使用
Русский	Предохранительное реле давления	Реле задержки времени	Синий	Чёрный	Коричневый	Отсоедините провод L-1, если используется реле задержки времени	Отсоедините провод 1-2, если используется термостат 2
DEUTSCH	Sicherheitsdruckschalter	Zeitrelais (verzögernd)	Blau	Schwarz	Braun	Bei Benutzung der Anlaufverzögerung Brücke L-1 entfernen	Bei Benutzung von Thermostat 2 Brücke 1-2 entfernen
FRANÇAIS	Pressostat	Relais de temporisation	Bleu	Noir	Marron	Supprimer la connection L-1 si le relais de temporisation est utilisé	Supprimer la connection 1-2 si thermostat 2 est utilisé
ESPAÑOL	Presostato de seguridad	Relé de retardo	Azul	Negro	Marrón	Quitar cable L-1, si se utiliza un relé de retardo	Quitar cable 1-2, si se utiliza el termostato 2
ITALIANO	Pressostato	Relè di ritardo avviam.	Blu	Nero	Marrone	Eliminare il cavo L-1 se è utilizzato il ritardatore	Eliminare il cavo 1-2 se è utilizzato il termostato 2
NEDERLANDS	Pressostaat	Tijdvertraging-relais	Blauw	Zwart	Bruin	Verwijder draad L-1 indien tijdvertraging wordt toegepast	Verwijder draad 1-2 indien thermostaat wordt toegepast
DANSK	Sikkerhedspressostat	Tidsforsinkel-sesrelæ	Blå	Sort	Brun	Ved tidsforsinkelse fjernes ledning L-1	Ved termostat 2 fjernes ledning 1-2
SVENSKA	Säkerhetspressostat	Tidsfördröjningsrelä	Blå	Svart	Brun	Vid anslutning av tidsfördröjningsrelä avlägsnas bygling L-1	Vid anslutning av termostat 2 avlägsnas bygling 1-2

Secop accepts no responsibility for possible errors in catalogs, brochures, and other printed material. Secop reserves the right to alter its products without notice. This also applies to products already on order provided that such alterations can be made without subsequent changes being necessary to specifications already agreed. All trademarks in this material are the property of the respective companies. Secop and the Secop logotype are trademarks of Secop GmbH. All rights reserved. www.secop.com