

Single Pack SC18/18CLX.2 220-240V 50Hz CSIR

Single pack code number: **195B3442**

Position	Title	Code	Amount
1	Compressor SC18/18CLX.2	104L4035	1
2	Starting relay	117U6013	2
3	Starting capacitor (125 μ F 220V, 6.3mm)	117U5012	2
4	Cord relief	103N1004	2
5	Cover	103N2009	2
6	Snap-on in quantities \varnothing 7,3 \varnothing 16mm	118-1919	2

Secop GmbH • Lise-Meitner-Straße 29 • 24941 Flensburg, Germany • Tel: +49 461 4941 0 • www.secop.com

Secop accepts no responsibility for possible errors in catalogs, brochures, and other printed material. Secop reserves the right to alter its products without notice. This also applies to products already on order provided that such alterations can be made without subsequent changes being necessary to specifications already agreed. All trademarks in this material are the property of the respective companies. Secop and the Secop logotype are trademarks of Secop GmbH. All rights reserved.

Model

Designation	SC18/18CLX.2	220-240V/50Hz 1~	Sales code:	104L4035
-------------	---------------------	------------------	-------------	-----------------

Compressor design

Oil type	Polyolester	Refrigerant(s)	R404A, R507
Oil viscosity	32cST	Displacement	35,36cm ³ / 2,16cu.in
Oil quantity	1233cm ³ / 41,7fl.oz	Compressors on pallet	18
Refr. charge - tech. limit	2200g / 77,6oz		
Free gas volume comp.	2920cm ³ / 98,7fl.oz		
Weight	29,1kg / 64,2lbs		
Motor protection	1# internal		
Winding resistance main	3,3Ω (at 25°C)		
Winding resistance aux	16,5Ω (at 25°C)		
Max. winding temp.	125°C / 257°F		
Max. discharge temp.	135°C / 275°F		



General - Configurations with SC18/18CLX.2

	Conf. 1
Motorconfiguration	CSIR
Power supply (nominal)	220-240V/50Hz
Number of phases	1
Voltage range	198-254V
Approvals	CCC, VDE, EAC
Starting torque	HST
Note	- / -

Applications with SC18/18CLX.2

	Conf. 1
Refrigerant	R404A
Application	LBP
System cooling	fan 3m/s
Hot gas defrost	OK
Long interval pull down	OK

Electrical data - Configurations with SC18/18CLX.2

	Conf. 1
Starting device type	relay
Run capacitor	- / -
Start capacitor	80μF
LRA (locked rotor amps / 4s)	2x 23,5A
RLA (rated load amps / 1s)	2x 4,5A
Cut in current	2x 23,5A

Model

Designation

SC18/18CLX.2

220-240V/50Hz 1~

Sales code:

104L4035
Compressor dimensions

Housing	A Height	259mm / 10,2in
	B Height	254mm / 10in
	B1	193mm / 7,6in
	B2	110mm / 4,33in

Connectors		Suction	Discharge	Process
		C	E	D
Diameter	[mm]	øi 15,21-15,37	øi 6,11-6,29	øi 6,11-6,29
(i:inside, o:outside)	[in]	øi 0,6-0,61	øi 0,24-0,25	øi 0,24-0,25
Material		steel	copper	copper
Horizontal angle	±2°	0°	37°	37°
Vertical angle	±2°	0°	0°	0°
Position l/h/w	[mm]	0/0/0	0/0/0	0/0/0
	[in]	0/0/0	0/0/0	0/0/0
Straight tube l.	[mm]	10	12	12
	[in]	0,4	0,5	0,5

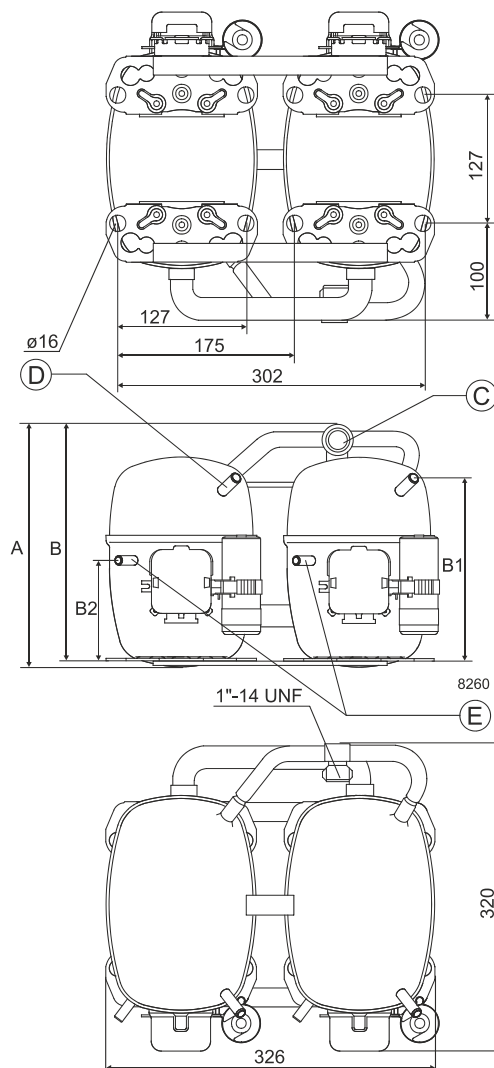
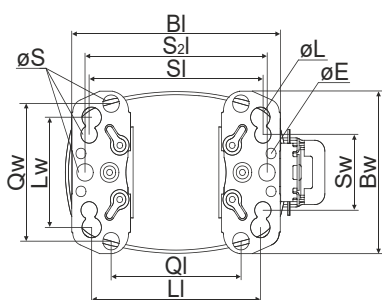
Compressor fixation

Baseplate	[mm]	[inch]
BI	204	8.03
Bw	150	5.9
øE	ø 9.7	ø 0.38
Large holes		
LI	165	6.5
Lw	101.6	4
øL	ø 19	ø 0.75
Small holes		
SI	170	6.7
Sw	70	2.76
øS	ø 16	ø 0.63
QI	127	5
Qw	127	5

Mounting accessories

	one comp.	multi pack
Bolt joint M6 ø16mm	118-1917	118-1918
Bolt joint ø1/4" ø16mm	118-1946	
Bolt joint ø1/4" ø19mm	118-1949	
Snap-on ø7,3 ø16mm	118-1947	118-1919

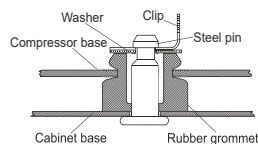
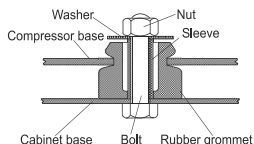
Bolt joint
Snap-on

Application notes

Provision for PE Grounding is located at the PE Stamp on the compressor

Twin should be used with a time-delay relay

Model

Designation	SC18/18CLX.2	220-240V/50Hz	Conf. 1	Sales code:	104L4035
-------------	---------------------	----------------------	----------------	-------------	-----------------

Configuration

Motorconfiguration	CSIR
Power supply (nominal)	220-240V/50Hz 1~
Refrigerant	R404A
Application	LBP
Voltage range	198-254V
Starting torque	HST
Approvals	CCC, VDE, EAC

Ambient/ machine room temperatures minimum /maximum

Ambient temperature range:	10 - 38°C / 50 - 101°F
Machine room temperature range:	10 - 43°C / 50 - 110°F
Compressor cooling:	fan 3m/s

Operation Limits

Electrical accessories / wiring diagram

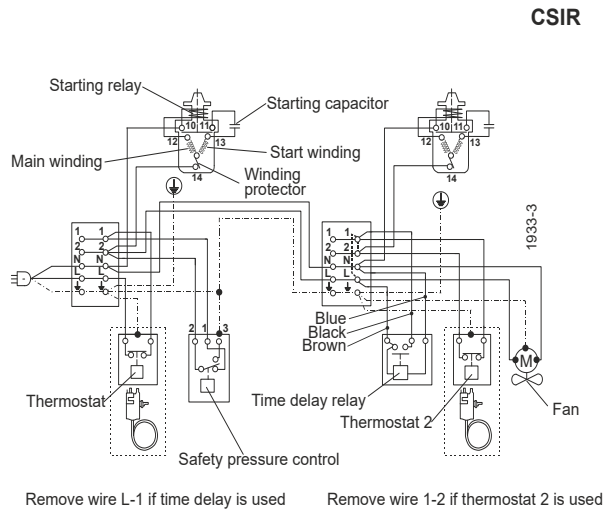
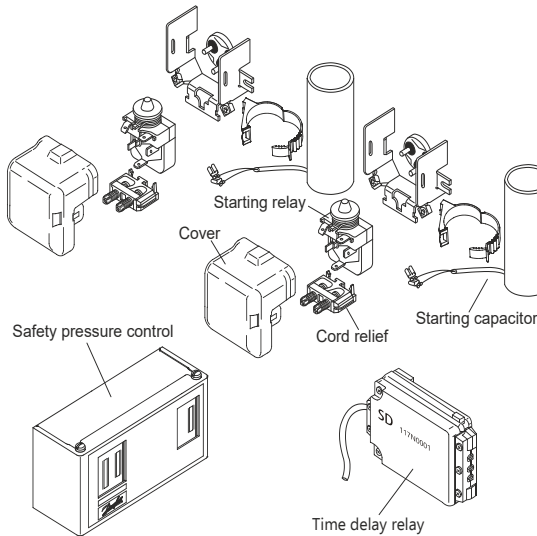

Operation pressure range

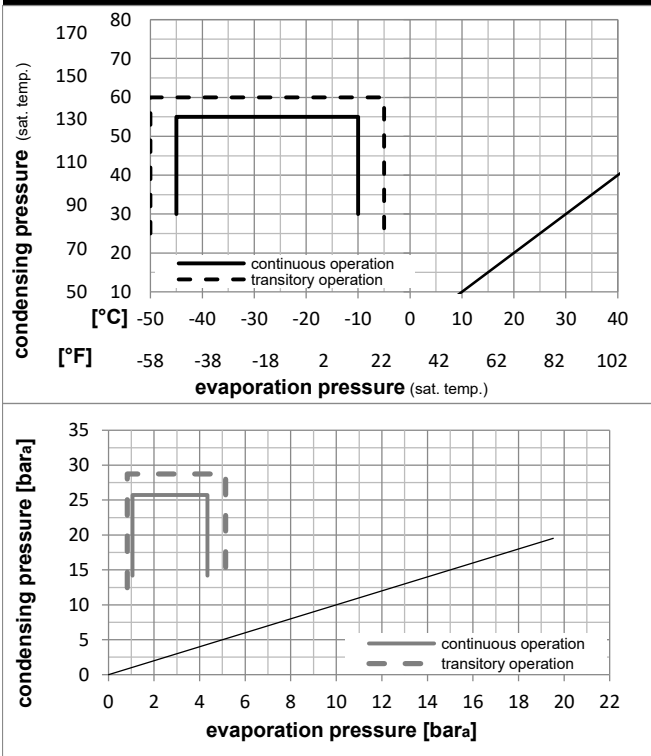

Components

a2	relay	117U6013
c	start capacitor (125µF)	117U5012
d	cord relief	103N1004
b	plastic cover	103N2009
.	Check valve (to be used with time-delay relay)	020-1014
.	Service valve 16mm	118-7351
.	Solder connector (alternative) 16 mm	118-7405
.	Seal ring for service valve and solder conn.	118-3638

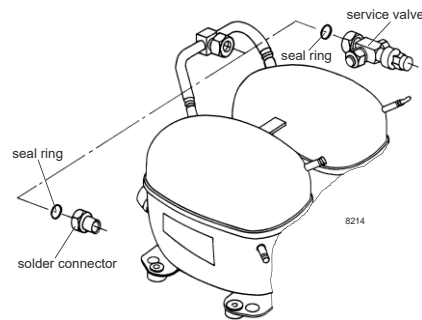

Model

Designation **SC18/18CLX.2 220-240V/50Hz** Conf. 1 Sales code: **104L4035**

Optimization + standard conditions

R404A, 220V/50Hz, CSIR, fan 3m/s, CCC, VDE, EAC

		Evaporating pressure (saturation temperature)				Condensing pressure (saturation temperature)					Power consumption				
		Return gas temp.		Liquid temp.		Cooling capacity			COP	EER	P1		Current consumption		Ref. mass flow
		pe	pc	RGT	Tliq	[W]	[Btu/h]	[kcal/h]	[W/W]	[Btu/W/h]	[kcal/W/h]	[W]	I	m	[kg/h]
[°C]	[°F]	[°C]	[°F]	[°C]	[°C]								[A]		
-23	-10	54	130	32	32	1756,7	6000	1511,8	1,20	4,08	1,03	1469,4	8,91	40,93	ASHRAE LBP
-25	-13	55	131	32	55	1182,3	4038	1017,5	0,84	2,86	0,72	1409,4	8,68	36,95	cecomaf LBP
-35	-31	40	104	20	40	953,9	3258	820,9	0,93	3,18	0,80	1023,5	7,37	25,92	EN12900 LBP
-23	-10	49	120	4,4	49	1327,5	4534	1142,4	0,93	3,16	0,80	1432,6	8,84	47,00	ARI540 LBP
-23	-10	41	105	32	32	2031,7	6939	1748,5	1,47	5,02	1,27	1381,9	8,68	47,34	AHAM LBP
-35	-31	45	113	32	45	871,0	2975	749,6	0,85	2,89	0,73	1029,0	7,37	23,29	opt

Performance tables

R404A, 220V/50Hz, CSIR, fan 3m/s, CCC, VDE, EAC

	pe		Cooling capacity			COP	EER	P1		I	m
	[°C]	[°F]	[W]	[Btu/h]	[kcal/h]	[W/W]	[Btu/W/h]	[kcal/W/h]	[W]	[A]	[kg/h]
[°C / °F]	-45	-49	385,2	1315	331,5	0,55	1,87	0,47	704,4	6,25	10,23
cond. pressure	-35	-31	871,0	2975	749,6	0,85	2,89	0,73	1029,0	7,37	23,29
pc= 45/113	-30	-22	1183,1	4040	1018,1	0,99	3,40	0,86	1189,3	7,95	31,76
return gas temp.	-25	-13	1550,0	5294	1334,0	1,15	3,91	0,99	1352,5	8,56	41,81
RGT= 32/90	-20	-4	1978,5	6757	1702,8	1,30	4,44	1,12	1521,5	9,19	53,68
liquid temp	-15	5	2475,3	8453	2130,2	1,46	4,97	1,25	1699,2	9,84	67,62
Tliq= 45/113	-10	14	3046,8	10405	2622,1	1,61	5,51	1,39	1888,9	10,51	83,90
[°C / °F]	-45	-49	183,6	627	158,0	0,29	0,98	0,25	637,6	6,01	5,64
cond. pressure	-35	-31	604,6	2065	520,3	0,59	2,00	0,51	1029,9	7,30	18,70
pc= 55/131	-30	-22	870,5	2973	749,2	0,71	2,44	0,61	1219,8	7,98	27,05
return gas temp	-25	-13	1182,3	4038	1017,5	0,84	2,86	0,72	1409,4	8,68	36,95
RGT= 32/90	-20	-4	1546,5	5282	1330,9	0,97	3,30	0,83	1602,0	9,40	48,66
liquid temp	-15	5	1969,8	6727	1695,2	1,09	3,74	0,94	1800,4	10,14	62,47
Tliq= 55/131	-10	14	2458,8	8397	2116,1	1,22	4,18	1,05	2007,6	10,90	78,71

SC Twin Compressors

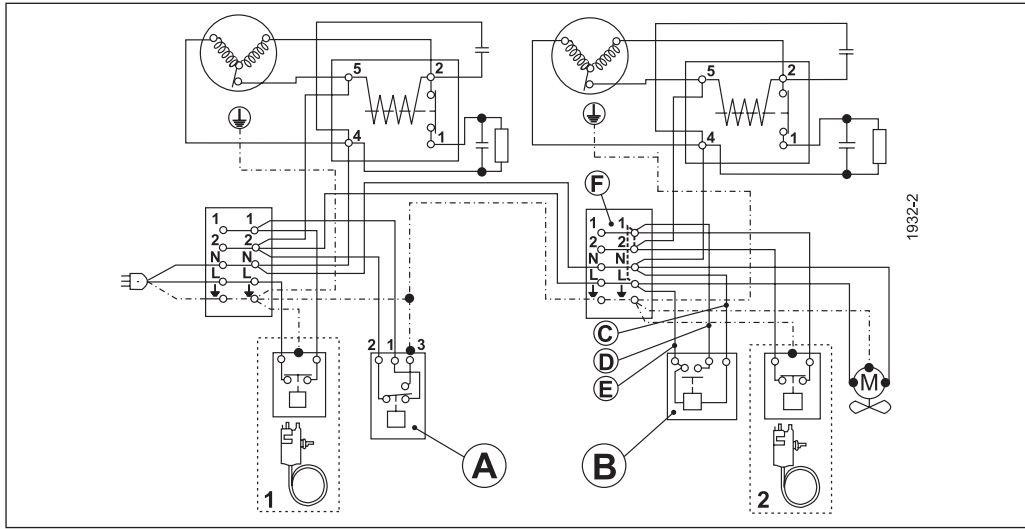
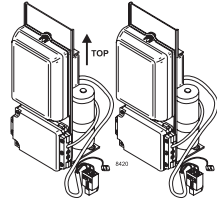
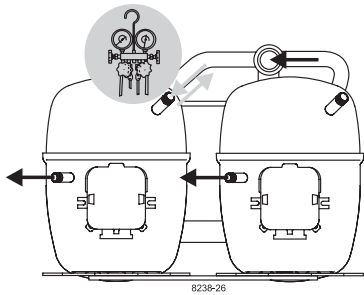

	A	B	C	D	E	F	
ENGLISH	Safety pressure control	Time delay relay	Blue	Black	Brown	Remove wire L-1 if time delay is used	Remove wire 1-2 if thermostat 2 is used
中文	安全压力控制	延时继电器	蓝	黑	棕	若延时继电器使用，线L-1不使用	若温控器2使用，线1-2不使用
Русский	Предохранительное реле давления	Реле задержки времени	Синий	Чёрный	Коричневый	Отсоедините провод L-1, если используется реле задержки времени	Отсоедините провод 1-2, если используется термостат 2
DEUTSCH	Sicherheitsdruckschalter	Zeitrelais (verzögernd)	Blau	Schwarz	Braun	Bei Benutzung der Anlaßverzögerung Brücke L-1 entfernen	Bei Benutzung von Thermostat 2 Brücke 1-2 entfernen
FRANÇAIS	Pressostat	Relais de temporisation	Bleu	Noir	Marron	Supprimer la connection L-1 si le relais de temporisation est utilisé	Supprimer la connection 1-2 si thermostat 2 est utilisé
ESPAÑOL	Presostato de seguridad	Relé de retardo	Azul	Negro	Marrón	Quitar cable L-1, si se utiliza un relé de retardo	Quitar cable 1-2, si se utiliza el termostato 2
ITALIANO	Pressostato	Relè di ritardo avviam.	Blu	Nero	Marrone	Eliminare il cavo L-1 se è utilizzato il ritardatore	Eliminare il cavo 1-2 se è utilizzato il termostato 2
NEDERLANDS	Pressostaat	Tijdvertraging-relais	Blauw	Zwart	Bruin	Verwijder draad L-1 indien tijdvertraging wordt toegepast	Verwijder draad 1-2 indien thermostaat wordt toegepast
DANSK	Sikkerhedspressostat	Tidsforsinkelsesrelæ	Blå	Sort	Brun	Ved tidsforsinkelse fjernes ledning L-1	Ved termostat 2 fjernes ledning 1-2
SVENSKA	Säkerhetspressostat	Tidsfördröjningsrelä	Blå	Svart	Brun	Vid anslutning av tidsfördröjningsrelä avlägsnas bygling L-1	Vid anslutning av termostat 2 avlägsnas bygling 1-2

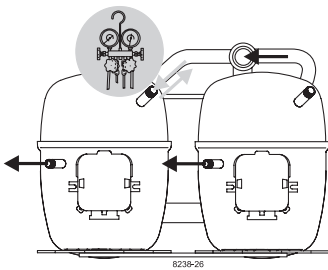

SC Twin Compressors

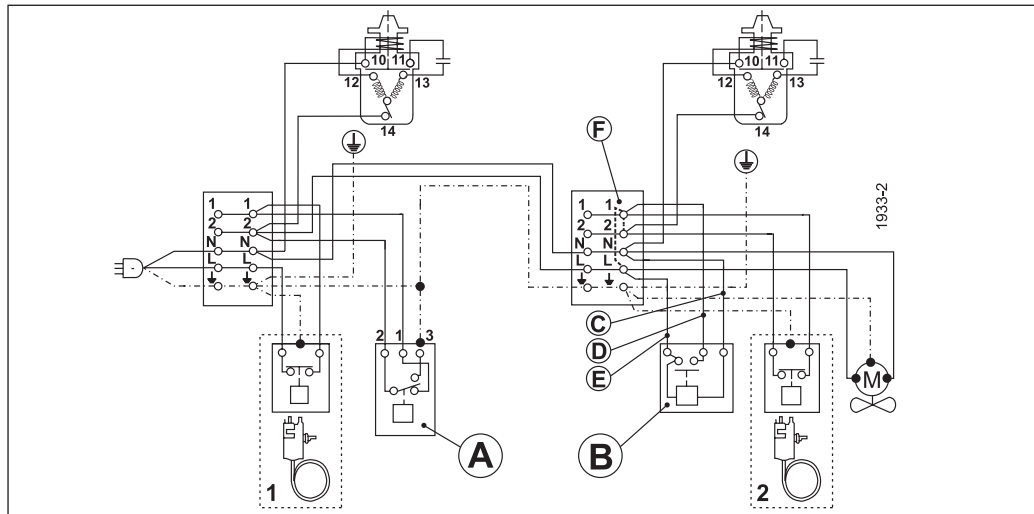
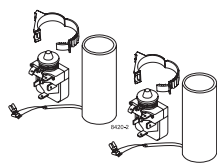

	A	B	C	D	E	F	
ENGLISH	Safety pressure control	Time delay relay	Blue	Black	Brown	Remove wire L-1 if time delay is used	Remove wire 1-2 if thermostat 2 is used
中文	安全压力控制	延时继电器	蓝	黑	棕	若延时继电器使用, 线L-1不使用	若温控器2使用, 线1-2不使用
Русский	Предохранительное реле давления	Реле задержки времени	Синий	Чёрный	Коричневый	Отсоедините провод L-1, если используется реле задержки времени	Отсоедините провод 1-2, если используется термостат 2
DEUTSCH	Sicherheitsdruckschalter	Zeitrelais (verzögernd)	Blau	Schwarz	Braun	Bei Benutzung der Anlaufverzögerung Brücke L-1 entfernen	Bei Benutzung von Thermostat 2 Brücke 1-2 entfernen
FRANÇAIS	Pressostat	Relais de temporisation	Bleu	Noir	Marron	Supprimer la connection L-1 si le relais de temporisation est utilisé	Supprimer la connection 1-2 si thermostat 2 est utilisé
ESPAÑOL	Presostato de seguridad	Relé de retardo	Azul	Negro	Marrón	Quitar cable L-1, si se utiliza un relé de retardo	Quitar cable 1-2, si se utiliza el termostato 2
ITALIANO	Pressostato	Relè di ritardo avviam.	Blu	Nero	Marrone	Eliminare il cavo L-1 se è utilizzato il ritardatore	Eliminare il cavo 1-2 se è utilizzato il termostato 2
NEDERLANDS	Pressostaat	Tijdvertraging-relais	Blauw	Zwart	Bruin	Verwijder draad L-1 indien tijdvertraging wordt toegepast	Verwijder draad 1-2 indien thermostaat wordt toegepast
DANSK	Sikkerhedspressostat	Tidsforsinkelsesrelæ	Blå	Sort	Brun	Ved tidsforsinkelse fjernes ledning L-1	Ved termostat 2 fjernes ledning 1-2
SVENSKA	Säkerhetspressostat	Tidsfördröjningsrelä	Blå	Svart	Brun	Vid anslutning av tidsfördröjningsrelä avlägsnas bygling L-1	Vid anslutning av termostat 2 avlägsnas bygling 1-2

Secop accepts no responsibility for possible errors in catalogs, brochures, and other printed material. Secop reserves the right to alter its products without notice. This also applies to products already on order provided that such alterations can be made without subsequent changes being necessary to specifications already agreed. All trademarks in this material are the property of the respective companies. Secop and the Secop logotype are trademarks of Secop GmbH. All rights reserved. www.secop.com