

## DLV5.7CN Variable Speed Drive Compressor R290, 220-240V 50/60Hz - with 105N4410 & 105N4510 Controllers



### General

Code number (without electronic unit)	102H3698
Electronic unit (without PFC)	105N4410
Approvals: EN 60335-2-34 with Annex AA (pending)	
Electronic unit (with PFC)	105N4510
Approvals: EN 60335-2-34 with Annex AA, CCC (pending)	
Compressors on pallet	100
Remarks: PFC = power factor correction according to EN 61000-3-2:2014	

### Application

Application	LBP/MBP			
	Hz	50	60	
Frequency	Hz	50	60	
Evaporating temperature	°C	-35 to 7.2	-35 to 7.2	
Voltage range / frequency	V/Hz	180 - 270	180 - 270	
Max. condensing temperature continuous (short)	°C	60 (65)	60 (65)	
Max. winding temperature continuous (short)	°C	125 (135)	125 (135)	

### Cooling requirements

Frequency	Hz	LBP/MBP					
		LBP	MBP	HBP	LBP	MBP	HBP
32°C		F <sub>2</sub>	F <sub>2</sub>	-	F <sub>2</sub>	F <sub>2</sub>	-
38°C		F <sub>2</sub>	F <sub>2</sub>	-	F <sub>2</sub>	F <sub>2</sub>	-
43°C		F <sub>2</sub>	F <sub>2</sub>	-	F <sub>2</sub>	F <sub>2</sub>	-

### Features

Speed range	rpm	2000 - 4500
Speed control		AEO, frequency, serial com.
Thermostat		integrated, electronic
Protections		current, speed, temperature
Protection class (electronic unit)		IP54

### Motor

Motor type		permanent magnet
LRA (rated after 4 sec. UL984),	A	electronic cut off
Maximum current	A	3.1
Resistance, all 3 windings (25°C)	Ω	4.1

### Design

Displacement	cm <sup>3</sup>	5.70
Oil quantity (type)	cm <sup>3</sup>	230 (polyolester)
Maximum refrigerant charge	g	150
Free gas volume in compressor	cm <sup>3</sup>	1390
Weight - Compressor/Electronic unit	kg	7.8 / 0.5

### Dimensions

Height	mm	A	175
		B	169
Suction connector	location/I.D. mm   angle	C	8.2   18°
		material   comment	Copper   Rubber plug
Process connector	location/I.D. mm   angle	D	6.2   61°
		material   comment	Copper   Rubber plug
Discharge connector	location/I.D. mm   angle	E	6.2   25°
		material   comment	Copper   Rubber plug
Connector tolerance	I.D. mm		±0.09

### Accessories

Accessories	Code number
Cover	103N0492
Cord relief	103N1010
Motor cable 900 mm cable length	105B4477

### Mounting accessories

Bolt joint for one compressor	Ø: 16 mm	118-1917
Bolt joint in quantities	Ø: 16 mm	118-1918
Snap-on in quantities	Ø: 16 mm	118-1919

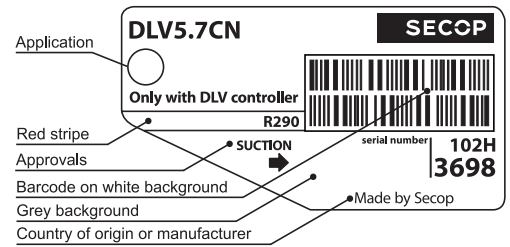

- S = Static cooling normally sufficient
- O = Oil cooling
- F<sub>1</sub> = Fan cooling 1.5 m/s (compressor compartment temp. equal to ambient temperature)
- F<sub>2</sub> = Fan cooling 3.0 m/s necessary
- SG = Suction gas cooling normally sufficient
- = not applicable in this area



Yellow warning label

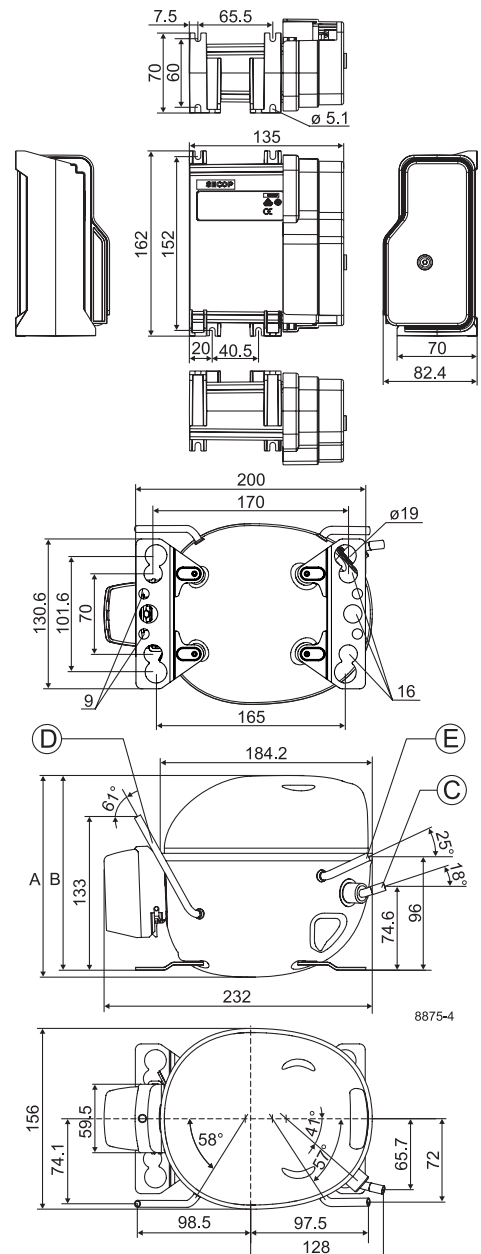

**LBP: ASHRAE** 230V, 50/60Hz, fan cooling F<sub>2</sub>

Speed (rpm)	2000	2250	2500	2750	3000	3500	4000	4500
Capacity [W]	185	212	239	266	293	346	400	448
Capacity [BTU/h]	631	724	817	909	1000	1183	1366	1530
Power cons. [W]	113	127	142	156	171	201	231	266
Current cons. [A]	0.55	0.61	0.66	0.73	0.79	0.92	1.05	1.19
COP [W/W]	1.64	1.67	1.69	1.70	1.71	1.72	1.73	1.69
EER [BTU/Wh]	5.61	5.70	5.77	5.81	5.84	5.89	5.92	5.75

**Test conditions**

Evaporation pressure	-23.3°C	-10°F
Condensing pressure	54.4°C	130°F
Liquid temperature	32.2°C	90°F
Return gas temperature	32.2°C	90°F

**LBP: CECOMAF** 230V, 50/60Hz, fan cooling F<sub>2</sub>

Speed (rpm)	2000	2250	2500	2750	3000	3500	4000	4500
Capacity [W]	138	158	178	199	219	260	301	337
Capacity [BTU/h]	470	539	608	678	748	887	1026	1150
Power cons. [W]	108	122	136	151	165	194	224	258
Current cons. [A]	0.53	0.58	0.64	0.70	0.77	0.89	1.02	1.15
COP [W/W]	1.27	1.29	1.31	1.32	1.33	1.34	1.35	1.31
EER [BTU/Wh]	4.34	4.41	4.47	4.50	4.52	4.56	4.59	4.46

**Test conditions**

Evaporation pressure	-25°C	-13°F
Condensing pressure	55°C	131°F
Liquid temperature	55°C	131°F
Return gas temperature	32°C	90°F

**LBP: EN12900** 230V, 50/60Hz, fan cooling F<sub>2</sub>

Speed (rpm)	2000	2250	2500	2750	3000	3500	4000	4500
Capacity [W]	103	118	133	148	167	194	225	252
Capacity [BTU/h]	351	403	455	507	559	664	768	861
Power cons. [W]	77	88	99	111	123	147	170	195
Current cons. [A]	0.41	0.45	0.49	0.54	0.59	0.69	0.79	0.88
COP [W/W]	1.34	1.34	1.35	1.34	1.33	1.33	1.32	1.30
EER [BTU/Wh]	4.57	4.58	4.59	4.57	4.56	4.53	4.51	4.42

**Test conditions**

Evaporation pressure	-35°C	-31°F
Condensing pressure	40°C	104°F
Liquid temperature	40°C	104°F
Return gas temperature	20°C	68°F

**MBP: ASHRAE** 230V, 50/60Hz, fan cooling F<sub>2</sub>

Speed (rpm)	2000	2250	2500	2750	3000	3500	4000	4500
Capacity [W]	339	389	439	481	523	608	692	775
Capacity [BTU/h]	1158	1329	1500	1644	1788	2075	2363	2647
Power cons. [W]	154	175	196	215	234	272	311	356
Current cons. [A]	0.71	0.81	0.91	0.99	1.07	1.24	1.40	1.58
COP [W/W]	2.20	2.23	2.25	2.24	2.24	2.23	2.23	2.18
EER [BTU/Wh]	7.51	7.60	7.67	7.65	7.64	7.62	7.60	7.44

**Test conditions**

Evaporation pressure	-6.7°C	20°F
Condensing pressure	54.4°C	130°F
Liquid temperature	46.1°C	115°F
Return gas temperature	35°C	95°F

**MBP: CECOMAF** 230V, 50/60Hz, fan cooling F<sub>2</sub>

Speed (rpm)	2000	2250	2500	2750	3000	3500	4000	4500
Capacity [W]	269	308	348	382	416	484	552	619
Capacity [BTU/h]	917	1053	1188	1304	1421	1653	1886	2113
Power cons. [W]	148	167	187	205	224	260	297	341
Current cons. [A]	0.68	0.78	0.87	0.95	1.03	1.19	1.34	1.51
COP [W/W]	1.82	1.84	1.86	1.86	1.86	1.86	1.86	1.82
EER [BTU/Wh]	6.21	6.29	6.36	6.36	6.35	6.35	6.35	6.20

**Test conditions**

Evaporation pressure	-10°C	14°F
Condensing pressure	55°C	131°F
Liquid temperature	55°C	131°F
Return gas temperature	32°C	90°F

**MBP: EN12900** 230V, 50/60Hz, fan cooling F<sub>2</sub>

Speed (rpm)	2000	2250	2500	2750	3000	3500	4000	4500
Capacity [W]	298	342	386	422	459	533	606	679
Capacity [BTU/h]	1017	1167	1317	1442	1568	1820	2071	2320
Power cons. [W]	131	149	168	185	203	238	273	311
Current cons. [A]	0.62	0.71	0.79	0.87	0.94	1.09	1.24	1.38
COP [W/W]	2.28	2.29	2.30	2.28	2.26	2.24	2.22	2.19
EER [BTU/Wh]	7.78	7.81	7.84	7.78	7.73	7.65	7.59	7.46

**Test conditions**

Evaporation pressure	-10°C	14°F
Condensing pressure	45°C	113°F
Liquid temperature	45°C	113°F
Return gas temperature	20°C	68°F

**Optimization Point** 230V, 50/60Hz, fan cooling F<sub>2</sub>

Speed (rpm)	2000	2250	2500	2750	3000	3500	4000	4500
Capacity [W]	184	211	238	264	290	341	393	440
Capacity [BTU/h]	628	721	814	902	990	1166	1343	1504
Power cons. [W]	92	105	118	132	147	176	205	233
Current cons. [A]	0.47	0.52	0.56	0.63	0.69	0.81	0.94	1.05
COP [W/W]	1.99	2.01	2.02	2.00	1.97	1.94	1.92	1.89
EER [BTU/Wh]	6.80	6.86	6.91	6.81	6.74	6.62	6.54	6.45

**Test conditions**

Evaporation pressure	-25°C	-13°F
Condensing pressure	35°C	95°F
Liquid temperature	35°C	95°F
Return gas temperature	32°C	90°F

**Optimization Point** 230V, 50/60Hz, fan cooling F<sub>2</sub>

Speed (rpm)	2000	2250	2500	2750	3000	3500	4000	4500
Capacity [W]	310	356	401	440	478	555	631	707
Capacity [BTU/h]	1059	1215	1371	1502	1632	1894	2156	2415
Power cons. [W]	131	149	168	185	203	238	273	311
Current cons. [A]	0.62	0.71	0.79	0.87	0.94	1.09	1.24	1.38
COP [W/W]	2.37	2.38	2.39	2.37	2.36	2.33	2.32	2.27
EER [BTU/Wh]	8.1	8.13	8.16	8.1	8.05	7.96	7.9	7.77

**Test conditions**

Evaporation pressure	-10°C	14°F
Condensing pressure	45°C	113°F
Liquid temperature	45°C	113°F
Return gas temperature	32°C	90°F

**Optimization Point** 230V, 50/60Hz, fan cooling F<sub>2</sub>

Speed (rpm)	2000	2250	2500	2750	3000	3500	4000	4500
Capacity [W]	533	612	690	754	818	946	1074	1203
Capacity [BTU/h]	1821	2090	2358	2576	2794	3231	3667	4107
Power cons. [W]	150	172	195	216	238	281	324	368
Current cons. [A]	0.69	0.80	0.90	1.00	1.09	1.27	1.46	1.63
COP [W/W]	3.55	3.55	3.55	3.49	3.44	3.37	3.32	3.27
EER [BTU/Wh]	12.12	12.12	12.12	11.92	11.76	11.51	11.32	11.16

**Test conditions**

Evaporation pressure	5°C	41°F
Condensing pressure	45°C	113°F
Liquid temperature	45°C	113°F
Return gas temperature	32°C	90°F

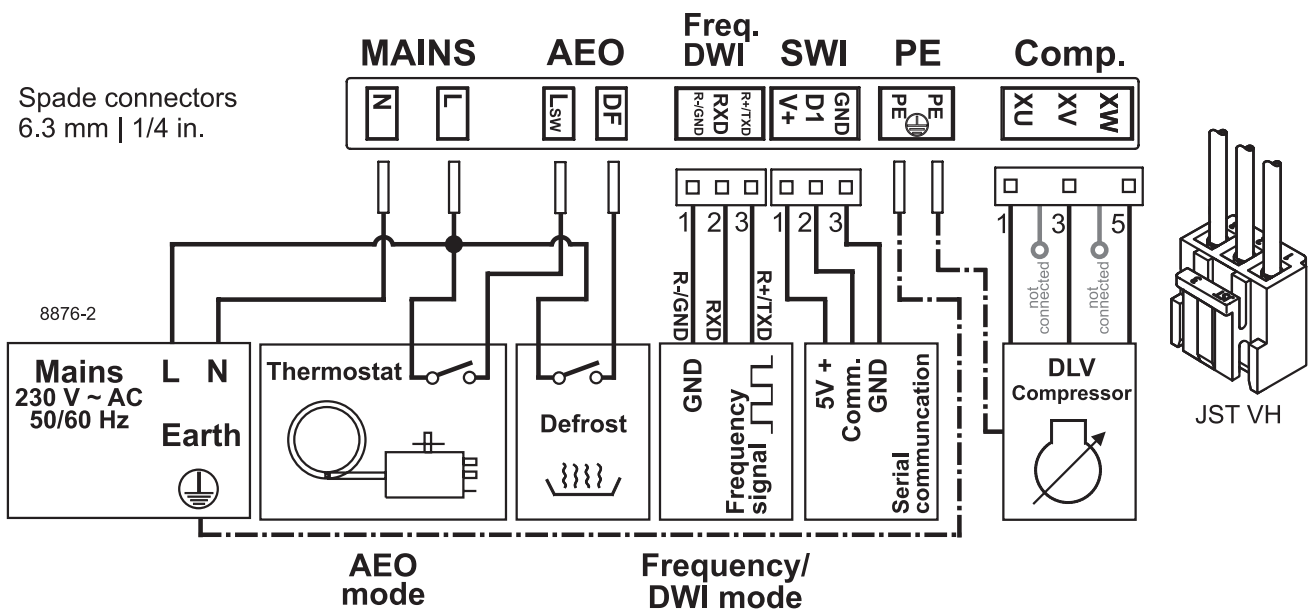
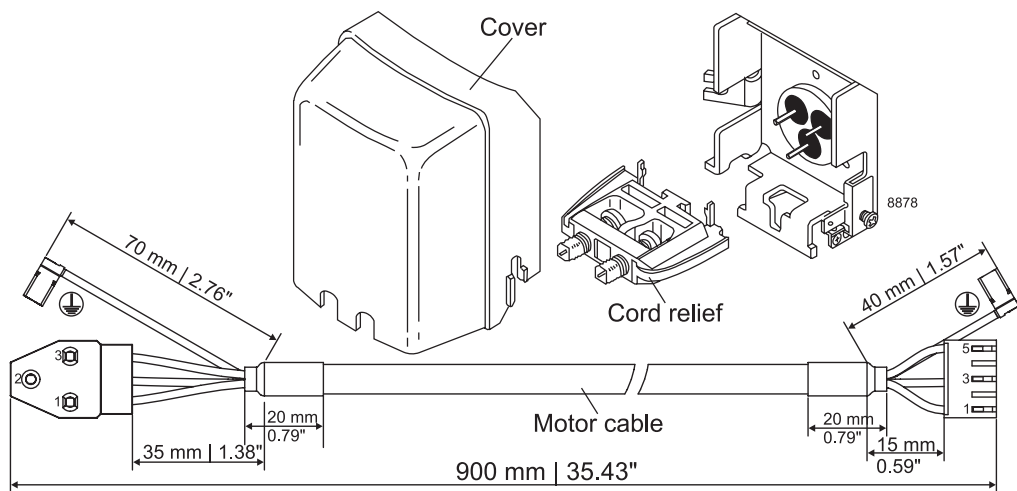
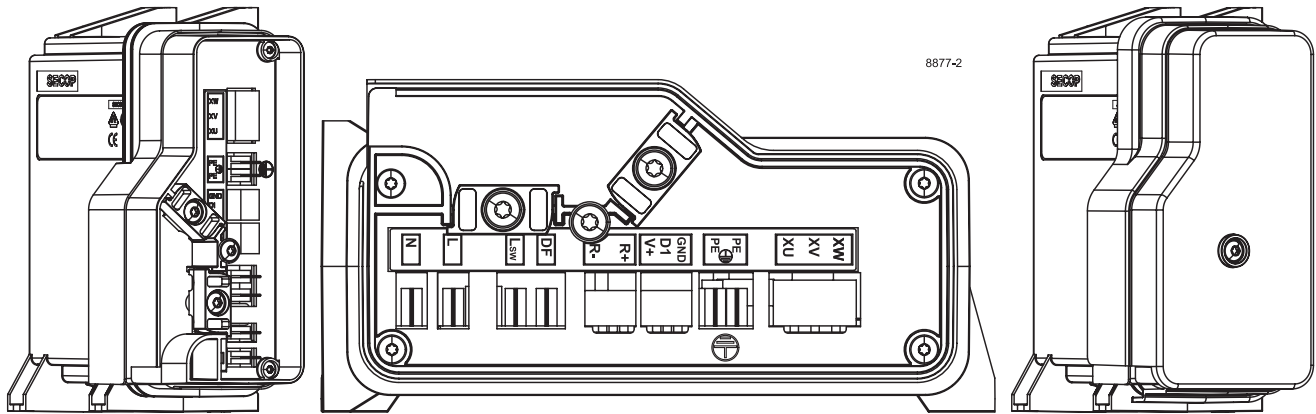

Secop accepts no responsibility for possible errors in catalogs, brochures, and other printed material. Secop reserves the right to alter its products without notice. This also applies to products already on order provided that such alterations can be made without subsequential changes being necessary to specifications already agreed. All trademarks in this material are the property of the respective companies. Secop and the Secop logotype are trademarks of Secop GmbH. All rights reserved. [www.secop.com](http://www.secop.com)