

## NL8.4CNX.2 LBP/MBP Compressor R290 115V 60Hz

### General

Code number	105H6090
Approvals	UL984
Compressors on pallet	80

### Application

Application	LBP/MBP			
	Hz	50	60	
Frequency	Hz	50	60	
Evaporating temperature	°F	-	-40 to 45	
Voltage range	V	-	95 - 135	
Max. condensing temperature continuous (short)	°F	-	131 (149)	
Max. winding temperature continuous (short)	°F	-	257 (275)	

### Cooling requirements

Frequency	Hz	50			60		
		LBP	MBP	HBP	LBP	MBP	HBP
90°F		-	-	-	F <sub>2</sub>	F <sub>2</sub>	-
100°F		-	-	-	F <sub>2</sub>	F <sub>2</sub>	-
110°F		-	-	-	F <sub>2</sub>	F <sub>2</sub>	-
Remarks on application:							

### Motor

Motor type	CSIR		
LRA (rated after 4 sec. UL984), HST   LST	A	26.4	-
Cut in Current, HST   LST	A	26.4	-
Resistance, main   start winding (77°F)	Ω	1.3	7.0

### Design

Displacement	cu.in	0.51
Oil quantity (type)	fl.oz.	9.13 (polyolester)
Maximum refrigerant charge	oz.	5.3
Free gas volume in compressor	fl.oz.	78.1
Weight without electrical equipment	lbs.	23.1

### Dimensions

Height	inch	A	7.99
		B	7.76
		B1	-
		B2	-
Suction connector	location, I.D. in.   angle	C	0.320-0.327   15°
		material   comment	Copper   Rubber plug
Process connector	location, I.D. in.   angle	D	0.252-0.259   25°
		material   comment	Copper   Rubber plug
Discharge connector	location, I.D. in.   angle	E	0.252-0.259   35°
		material   comment	Copper   Rubber plug
Oil cooler connector	location, I.D. in.   angle	F	-
		material   comment	-
Remarks:			

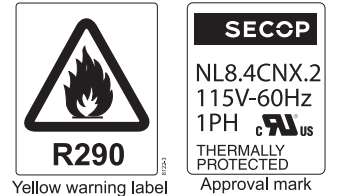
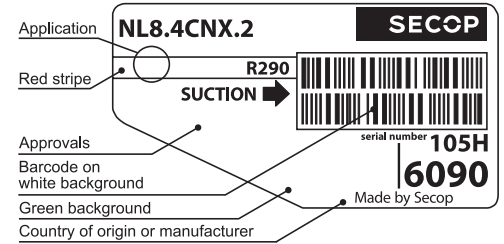

- S = Static cooling normally sufficient
- O = Oil cooling
- F<sub>1</sub> = Fan cooling 1.5 m/s (compressor compartment temperature equal to ambient temperature)
- F<sub>2</sub> = Fan cooling 3.0 m/s necessary
- SG = Suction gas cooling normally sufficient
- = not applicable in this area

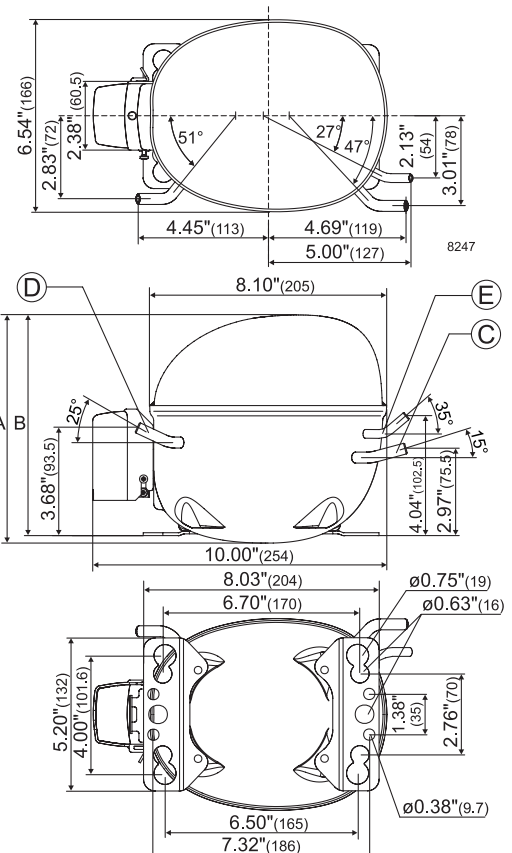

**ASHRAE LBP**

115V, 60Hz, fan cooling F<sub>2</sub>

Evap. temp. in °F	-49	-40	-30	-20	-13	-10	0	10	14	20	30	32	40	41	45	50	59
Capacity in BTU/h		656	939	1268	1534	1657	2120	2670	2918	3322	4089	4258	4258	4987	5489		
Power cons. in W		217	253	291	319	331	372	414	430	454	493	501	501	530	547		
Current cons. in A		3.38	3.57	3.80	3.98	4.06	4.35	4.66	4.79	4.98	5.29	5.36	5.36	5.60	5.75		
EER in BTU/Wh		3.02	3.72	4.36	4.81	5.01	5.70	6.46	6.79	7.31	8.29	8.50	8.50	9.41	10.04		

**ASHRAE MBP/HBP**

115V, 60Hz, fan cooling F<sub>2</sub>

Evap. temp. in °F	-49	-40	-30	-20	-13	-10	0	10	14	20	30	32	40	41	45	50	59
Capacity in BTU/h		593	848	1145	1384	1496	1913	2408	2631	2995	3684	3836	4490	4577	4940		
Power cons. in W		217	253	291	319	331	372	414	430	454	493	501	530	533	547		
Current cons. in A		3.38	3.57	3.80	3.98	4.06	4.35	4.66	4.79	4.98	5.29	5.36	5.60	5.63	5.75		
EER in BTU/Wh		2.73	3.36	3.94	4.34	4.52	5.14	5.82	6.12	6.59	7.47	7.66	8.47	8.58	9.03		

**EN 12900 Household (CECOMAF)\*** 115V, 60Hz, fan cooling F<sub>2</sub>

Evap. temp. in °F	-49	-40	-30	-20	-13	-10	0	10	14	20	30	32	40	41	45	50	59
Capacity in W		193	268	357	429	462	587	735	801	909	1112	1157	1348	1373	1478		
Power cons. in W		220	251	284	307	318	352	386	399	418	448	454	475	478	487		
Current cons. in A		3.40	3.56	3.75	3.90	3.97	4.21	4.45	4.55	4.70	4.94	4.98	5.16	5.18	5.26		
COP in W/W		0.88	1.07	1.26	1.40	1.46	1.67	1.90	2.01	2.17	2.48	2.55	2.83	2.87	3.03		

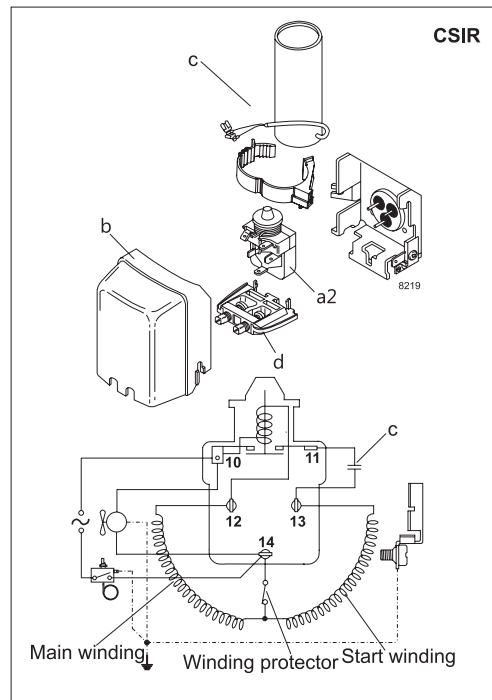

Accessories for	NL8.4CNX.2	Figure	Code number
PTC starting device	1/4 in. spade connect.	a1	—
	3/16 in. spade connect.		—
Starting relay	1/4 in. spade connect.	a2	117U7013
Cover		b	103N2011
Start. capacitor 125 µF	1/4 in. spade connect.	c	117U5035
Cord relief		d	103N1010

Test conditions	ASHRAE LBP	ASHRAE MBP/HBP	EN 12900/CECOMAF*
Condensing temp.	130°F	130°F	113°F
Ambient temp.	90°F	90°F	90°F
Suction gas temp.	90°F	95°F	90°F
Liquid temperature	90°F	115°F	no subcooling

Mounting accessories		Code number
Bolt joint for one comp.	Ø: 5/8 in.	118-1917
Bolt joint in quantities	Ø: 5/8 in.	118-1918
Snap-on in quantities	Ø: 5/8 in.	118-1919

Secop accepts no responsibility for possible errors in catalogs, brochures, and other printed material. Secop reserves the right to alter its products without notice. This also applies to products already on order provided that such alterations can be made without consequential changes being necessary to specifications already agreed. All trademarks in this material are the property of the respective companies. Secop and the Secop logotype are trademarks of Secop GmbH. All rights reserved. [www.secop.com](http://www.secop.com)