

SC18CNX LBP/MBP Compressor R290 220-240V 50Hz

General

Code number	104H8867
Approvals	EN 60335-2-34, CCC
Compressors on pallet	80

Application

Application	LBP/MBP		
Frequency	Hz	50	60
Evaporating temperature	°C	-40 to 5	-
Voltage range	V	198 - 254	-
Max. condensing temperature continuous (short)	°C	55 (65)	-
Max. winding temperature continuous (short)	°C	125 (135)	-

Cooling requirements

Frequency	Hz	50			60		
Application		LBP	MBP	HBP	LBP	MBP	HBP
32°C		F ₂	F ₂	-	-	-	-
38°C		F ₂	F ₂	-	-	-	-
43°C		F ₂	F ₂	-	-	-	-
Remarks on application:							

Motor

Motor type	CSR		
LRA (rated after 4 sec. UL984), HST LST	A	19.5	-
Cut in Current, HST LST	A	19.5	-
Resistance, main start winding (25°C)	Ω	4.6	17.8

Design

Displacement	cm ³	17.69
Oil quantity (type)	cm ³	550 (polyolester)
Maximum refrigerant charge	g	150
Free gas volume in compressor	cm ³	1460
Weight without electrical equipment	kg	13.5

Dimensions

Height	mm	A	209
		B	203
		B1	183
		B2	100
Suction connector	location/I.D. mm angle	C	9.7 37°
	material comment	Copper Rubber plug	
Process connector	location/I.D. mm angle	D	6.5 37°
	material comment	Copper Rubber plug	
Discharge connector	location/I.D. mm angle	E	6.5 37°
	material comment	Copper Rubber plug	
Oil cooler connector	location/I.D. mm angle	F	-
	material comment	-	
Connector tolerance	I.D. mm	±0.09	
Remarks:			

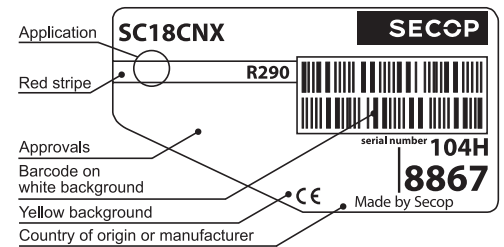

Yellow warning label

- S = Static cooling normally sufficient
- O = Oil cooling
- F₁ = Fan cooling 1.5 m/s
(compressor compartment temperature equal to ambient temperature)
- F₂ = Fan cooling 3.0 m/s necessary
- SG = Suction gas cooling normally sufficient
- = not applicable in this area

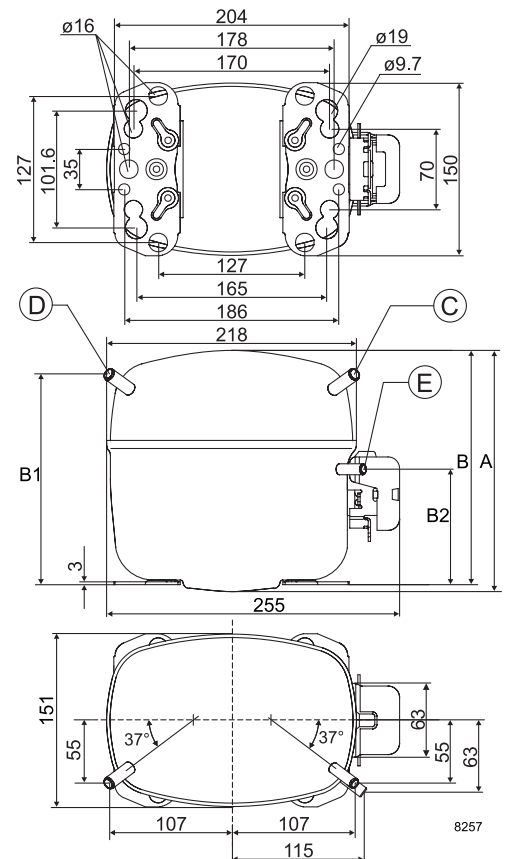

EN 12900 Household (CECOMAF)* 220V, 50Hz, fan cooling F₂

Evap. temp. in °C	-45	-40	-35	-30	-25	-23.3	-20	-15	-10	-6.7	-5	0	5	7.2	10	15	20
Capacity in W		219	341	480	640	700	824	1033	1272	1448	1543	1849	2193				
Power cons. in W		304	370	435	500	522	566	635	707	756	783	864	952				
Current cons. in A		1.80	2.08	2.34	2.60	2.68	2.85	3.09	3.32	3.47	3.54	3.76	3.97				
COP in W/W		0.72	0.92	1.10	1.28	1.34	1.45	1.63	1.80	1.91	1.97	2.14	2.30				

ASHRAE LBP* 220V, 50Hz, fan cooling F₂

Evap. temp. in °C	-45	-40	-35	-30	-25	-23.3	-20	-15	-10	-6.7	-5	0	5	7.2	10	15	20
Capacity in W		244	380	535	714	781	919	1154	1422	1618	1726	2070	2456				
Power cons. in W		304	370	435	500	522	566	635	707	756	783	864	952				
Current cons. in A		1.80	2.08	2.34	2.60	2.68	2.85	3.09	3.32	3.47	3.54	3.76	3.97				
COP in W/W		0.80	1.03	1.23	1.43	1.49	1.62	1.82	2.01	2.14	2.20	2.39	2.58				

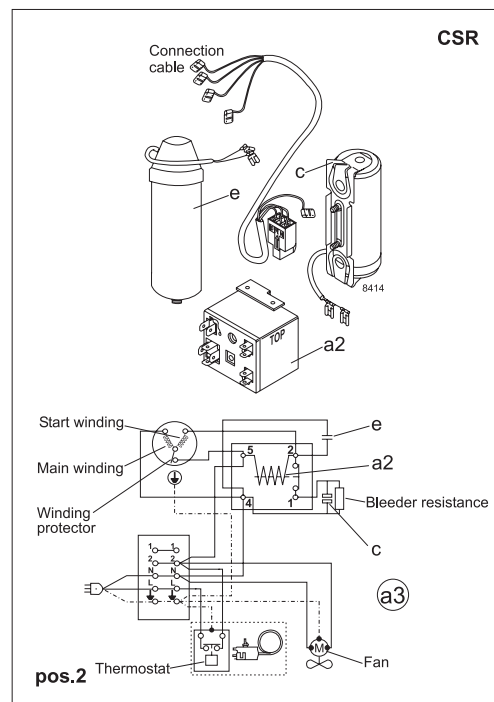
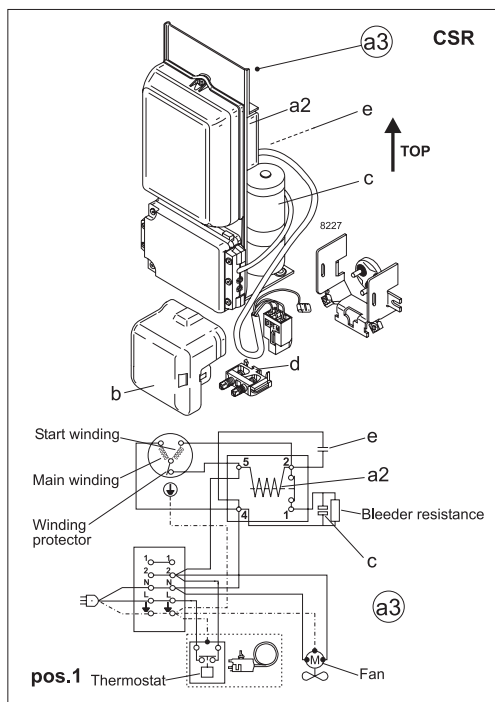

Accessories for	SC18CNX	Figure	Code number
Starting device	550 mm cable length	a3 (pos.1)	117-7052
Starting device (kit)	1000 mm cable length	(pos.2)	117-9718
Starting relay		a2	Components of starting device
Start. capacitor		c	
Run capacitor		e	
Cover		b	103N2009
Cord relief		d	103N1004

Test conditions	EN 12900/CECOMAF*	ASHRAE LBP*
Condensing temperature	45°C	45°C
Ambient temperature	32°C	32°C
Suction gas temperature	32°C	32°C
Liquid temperature	no subcooling	32°C

Mounting accessories	Code number	
Bolt joint for one comp.	Ø: 16 mm	118-1917
Bolt joint in quantities	Ø: 16 mm	118-1918
Snap-on in quantities	Ø: 16 mm	118-1919

Secop accepts no responsibility for possible errors in catalogs, brochures, and other printed material. Secop reserves the right to alter its products without notice. This also applies to products already on order provided that such alterations can be made without consequential changes being necessary to specifications already agreed. All trademarks in this material are the property of the respective companies. Secop and the Secop logotype are trademarks of Secop GmbH. All rights reserved. www.secop.com