

SC21F Standard Compressor R134a 220-240V 50Hz

General

Code number	104G8100
Approvals	EN 60335-2-34
Compressors on pallet	80

Application

Application	LBP		
Frequency	Hz	50	60
Evaporating temperature	°C	-35 to -5	-
Voltage range	V	198 - 254	-
Max. condensing temperature continuous (short)	°C	60 (70)	-
Max. winding temperature continuous (short)	°C	125 (135)	-

Cooling requirements

Frequency	Hz	50			60		
Application		LBP	MBP	HBP	LBP	MBP	HBP
32°C		F ₁	-	-	-	-	-
38°C		F ₁	-	-	-	-	-
43°C		-	-	-	-	-	-

Remarks on application:
Can be used as a HBP compressor with 240V 50Hz mains (216-254V).

Motor

Motor type	CSIR		
LRA (rated after 4 sec. UL984), HST LST	A	18.6	-
Cut in Current, HST LST	A	18.6	-
Resistance, main start winding (25°C)	Ω	3.7	14.1

Design

Displacement	cm ³	20.95
Oil quantity (type)	cm ³	550 (polyolester)
Maximum refrigerant charge	g	1300
Free gas volume in compressor	cm ³	1460
Weight without electrical equipment	kg	13.3

Dimensions

Height	mm	A	219
		B	213
		B1	193
		B2	110
Suction connector	location/I.D. mm angle	C	10.2 37°
	material comment		Copper Rubber plug
Process connector	location/I.D. mm angle	D	6.2 37°
	material comment		Copper Rubber plug
Discharge connector	location/I.D. mm angle	E	6.2 37°
	material comment		Copper Rubber plug
Oil cooler connector	location/I.D. mm angle	F	-
	material comment		-
Connector tolerance	I.D. mm		±0.09
Remarks:			

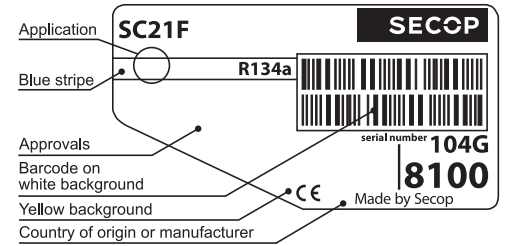

- S = Static cooling normally sufficient
- O = Oil cooling
- F₁ = Fan cooling 1.5 m/s
(compressor compartment temperature equal to ambient temperature)
- F₂ = Fan cooling 3.0 m/s necessary
- SG = Suction gas cooling normally sufficient
- = not applicable in this area

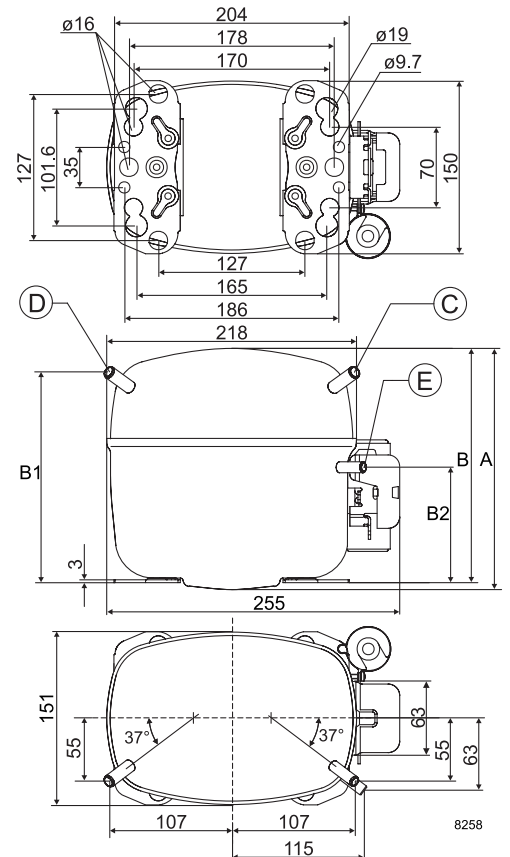

EN 12900 Household (CECOMAF) 220V, 50Hz, fan cooling F₁

Evap. temp. in °C	-45	-40	-35	-30	-25	-23.3	-20	-15	-10	-6.7	-5	0	5	7.2	10	15	20
Capacity in W			185	245	335	375	455	610	780	914	990						
Power cons. in W			275	325	380	405	450	520	600	657	685						
Current cons. in A			2.50	2.64	2.77	2.81	2.92	3.16	3.53	3.87	4.09						
COP in W/W			0.67	0.75	0.88	0.92	1.01	1.17	1.30	1.39	1.45						

ASHRAE LBP 220V, 50Hz, fan cooling F₁

Evap. temp. in °C	-45	-40	-35	-30	-25	-23.3	-20	-15	-10	-6.7	-5	0	5	7.2	10	15	20
Capacity in W			228	302	412	462	560	750	960	1130	1220						
Power cons. in W			275	325	380	405	450	520	600	657	685						
Current cons. in A			2.50	2.64	2.77	2.81	2.92	3.16	3.53	3.87	4.09						
COP in W/W			0.83	0.93	1.08	1.14	1.24	1.44	1.60	1.72	1.78						

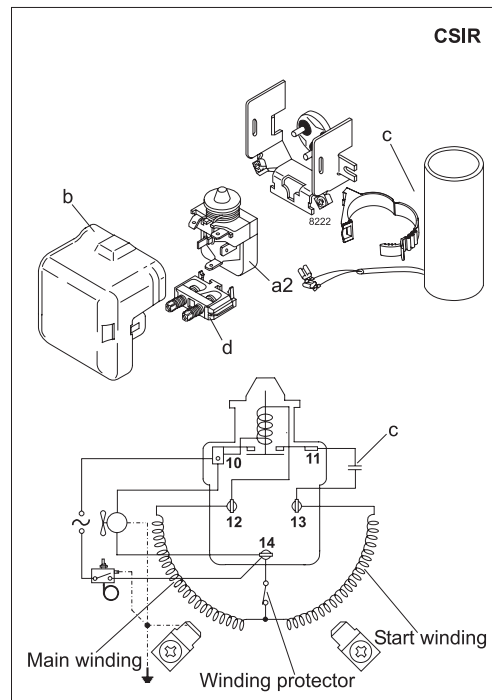

Accessories for	SC21F	Figure	Code number	Test conditions	EN 12900/CECOMAF	ASHRAE LBP
PTC starting device	6.3 mm spade connectors	a1	–	Condensing temperature	55°C	55°C
	4.8 mm spade connectors		–	Ambient temperature	32°C	32°C
Starting relay	6.3 mm spade connectors	a2	117U6019	Suction gas temperature	32°C	32°C
Cover		b	103N2009	Liquid temperature	55°C	32°C
Start. capacitor 80 µF	6.3 mm spade connectors	c	117U5017			
Cord relief		d	103N1004			
Protection screen for PTC		g	–			
				Mounting accessories		Code number
				Bolt joint for one comp.	Ø: 16 mm	118-1917
				Bolt joint in quantities	Ø: 16 mm	118-1918
				Snap-on in quantities	Ø: 16 mm	118-1919

Secop accepts no responsibility for possible errors in catalogs, brochures, and other printed material. Secop reserves the right to alter its products without notice. This also applies to products already on order provided that such alterations can be made without subsequential changes being necessary to specifications already agreed. All trademarks in this material are the property of the respective companies. Secop and the Secop logotype are trademarks of Secop GmbH. All rights reserved. www.secop.com