

NL6F Standard Compressor R134a 220-240V 50Hz

General

Code number	105G6606
Approvals	EN 60335-2-34 with Annex AA
Compressors on pallet	80

Application

Application	LBP		
Frequency	Hz	50	60
Evaporating temperature	°C	-35 to -10	-
Voltage range	V	198 - 254	-
Max. condensing temperature continuous (short)	°C	60 (70)	-
Max. winding temperature continuous (short)	°C	125 (135)	-

Cooling requirements

Frequency	Hz	50			60		
Application		LBP	MBP	HBP	LBP	MBP	HBP
32°C		S	-	-	-	-	-
38°C		S	-	-	-	-	-
43°C		-	-	-	-	-	-
Remarks on application:							

Motor

Motor type	RSIR/CSIR		
LRA (rated after 4 sec. UL984), HST LST	A	5.0	5.0
Cut in Current, HST LST	A	5.0	9.6
Resistance, main start winding (25°C)	Ω	16.0	13.6

Design

Displacement	cm ³	6.13
Oil quantity (type)	cm ³	270
Maximum refrigerant charge	g	400
Free gas volume in compressor	cm ³	2130
Weight without electrical equipment	kg	9.3

Dimensions

Height	mm	A	188
		B	181
		B1	-
		B2	-
Suction connector	location/I.D. mm angle	C	6.2 15°
	material comment		Cu-plated steel Al cap
Process connector	location/I.D. mm angle	D	6.2 25°
	material comment		Cu-plated steel Al cap
Discharge connector	location/I.D. mm angle	E	5.0 35°
	material comment		Cu-plated steel Al cap
Oil cooler connector	location/I.D. mm angle	F	-
	material comment		-
Connector tolerance	I.D. mm		±0.09, on 5.0 +0.12/+0.20
Remarks:			

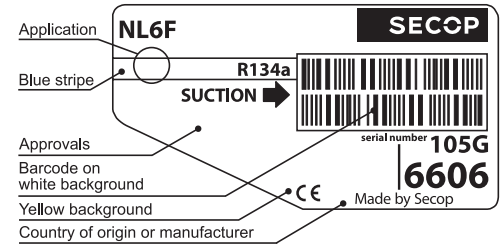

- S = Static cooling normally sufficient
- O = Oil cooling
- F₁ = Fan cooling 1.5 m/s
(compressor compartment temperature equal to ambient temperature)
- F₂ = Fan cooling 3.0 m/s necessary
- SG = Suction gas cooling normally sufficient
- = not applicable in this area

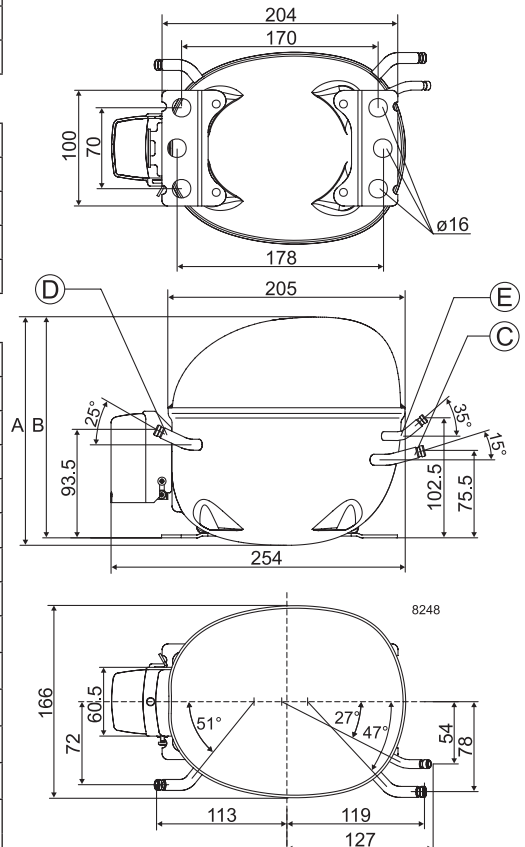

EN 12900 Household (CECOMAF) 220V, 50Hz, static cooling, PTC consumption incl.

Evap. temp in °C	-45	-40	-35	-30	-25	-23.3	-20	-15	-10	-6.7	-5	0	5	7.2	10	15	20
Capacity in W			52	77	110	123	151	200	258								
Power cons. in W			80	98	118	125	139	161	185								
Current cons. in A			0.78	0.81	0.86	0.88	0.92	0.99	1.08								
COP in W/W			0.65	0.78	0.93	0.99	1.09	1.24	1.39								

ASHRAE LBP 220V, 50Hz, static cooling, PTC consumption incl.

Evap. temp in °C	-45	-40	-35	-30	-25	-23.3	-20	-15	-10	-6.7	-5	0	5	7.2	10	15	20
Capacity in W			64	95	135	151	186	247	318								
Power cons. in W			80	98	118	125	139	161	185								
Current cons. in A			0.78	0.81	0.86	0.88	0.92	0.99	1.08								
COP in W/W			0.80	0.96	1.15	1.21	1.34	1.53	1.72								

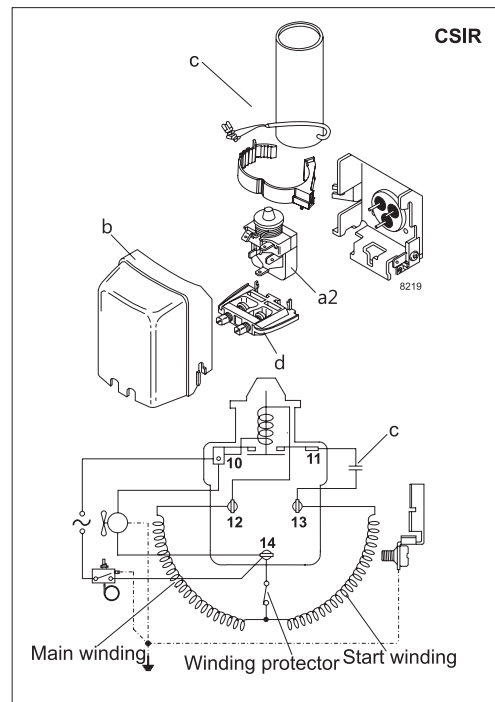
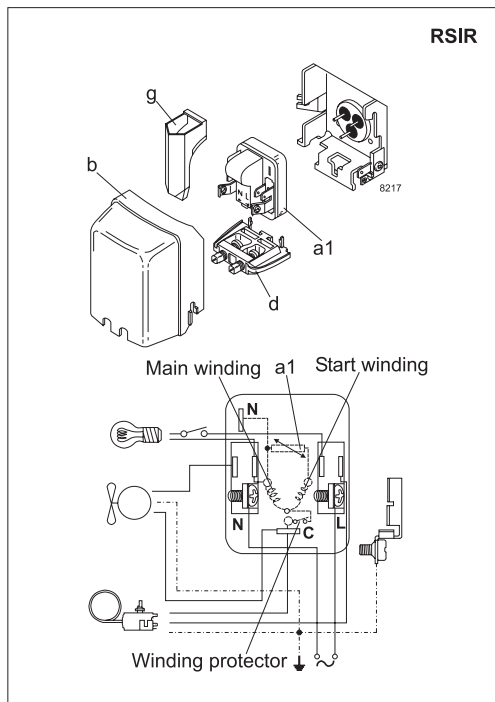

Accessories for	NL6F	Figure	Code number
PTC starting device	6.3 mm spade connectors	a1	103N0011
	4.8 mm spade connectors		103N0018
Starting relay	6.3 mm spade connectors	a2	117U6004
Start capacitor 80 µF	6.3 mm spade connectors	c	117U5015
Cover		b	103N2010
Cord relief		d	103N1010
Protection screen for PTC		g	103N0476

Test conditions	EN 12900/ CECOMAF	ASHRAE
Condensing temperature	55°C	55°C
Ambient temperature	32°C	32°C
Suction gas temperature	32°C	32°C
Liquid temperature	no subcooling	32°C

Mounting accessories	Code number	
Bolt joint for one comp.	Ø: 16 mm	118-1917
Bolt joint in quantities	Ø: 16 mm	118-1918
Snap-on in quantities	Ø: 16 mm	118-1919

Nidec GA Compressors accepts no responsibility for possible errors in catalogs, brochures, and other printed material. Nidec GA Compressors reserves the right to alter its products without notice. This also applies to products already on order provided that such alterations can be made without subsequential changes being necessary to specifications already agreed. All trademarks in this material are the property of the respective companies. Secop and the Secop logotype are trademarks of Nidec Global Appliance Germany GmbH. All rights reserved. www.secop.com