

NL8.4MF Standard Compressor R134a 220-240V 50Hz & 208-230V 60Hz

General

Code number	105G6877
Approvals	EN 60335-2-34, UL984
Compressors on pallet	80

Application

Application	MBP			
	Hz	50	60	
Frequency	Hz	50	60	
Evaporating temperature	°C	-20 to 15	-35 to 7.2	
Voltage range	V	187 - 254	198 - 254	
Max. condensing temperature continuous (short)	°C	60 (70)	60 (70)	
Max. winding temperature continuous (short)	°C	125 (135)	125 (135)	

Cooling requirements

Frequency	Hz	50			60		
		LBP	MBP	HBP	LBP	MBP	HBP
32°C		-	F ₁	F ₁	F ₁	F ₁	-
38°C		-	F ₁	F ₁	F ₁	F ₁	-
43°C		-	F ₁	F ₁	F ₁	F ₁	-

Remarks on application: F₂ for 230-240V 50Hz nominal below -12°C evaporating temp. CSIR strongly recommended for 60Hz

Motor

Motor type	RSIR/CSIR	
LRA (rated after 4 sec. UL984), HST LST	A	11.7 10.8
Cut in Current, HST LST	A	11.7 15.0
Resistance, main start winding (25°C)	Ω	7.1 15.4

Design

Displacement	cm ³	8.35
Oil quantity (type)	cm ³	270 (polyolester)
Maximum refrigerant charge	g	600
Free gas volume in compressor	cm ³	2360
Weight without electrical equipment	kg	10.5

Dimensions

Height	mm	A	197
		B	191
		B1	-
		B2	-
Suction connector	location/I.D. mm angle	C	8.2 90°
	material comment		Copper Rubber plug
Process connector	location/I.D. mm angle	D	6.2 90°
	material comment		Copper Rubber plug
Discharge connector	location/I.D. mm angle	E	6.2 0°
	material comment		Copper Rubber plug
Oil cooler connector	location/I.D. mm angle	F	-
	material comment		-
Connector tolerance	I.D. mm		±0.09
Remarks:			

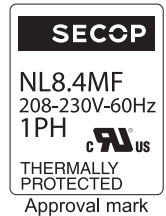
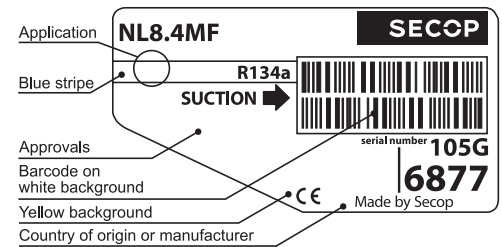

- S = Static cooling normally sufficient
- O = Oil cooling
- F₁ = Fan cooling 1.5 m/s (compressor compartment temperature equal to ambient temperature)
- F₂ = Fan cooling 3.0 m/s necessary
- SG = Suction gas cooling normally sufficient
- = not applicable in this area

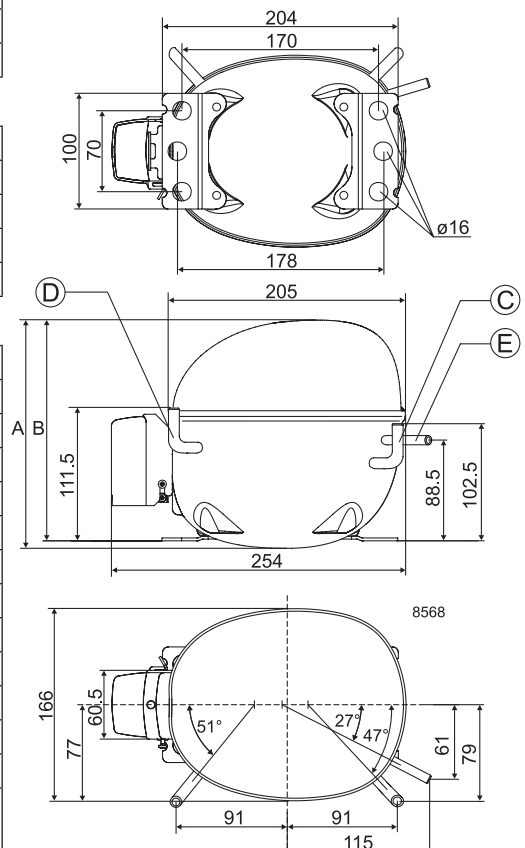

EN 12900 Household (CECOMAF) 220V, 50Hz, fan cooling F₁

Evap. temp. in °C	-45	-40	-35	-30	-25	-23.3	-20	-15	-10	-6.7	-5	0	5	7.2	10	15	20
Capacity in W							213	277	353	412	445	553	679	741	825	994	
Power cons. in W							208	234	261	279	289	318	349	364	383	419	
Current cons. in A							1.84	1.88	1.92	1.96	1.98	2.07	2.20	2.27	2.39	2.65	
COP in W/W							1.02	1.18	1.35	1.48	1.54	1.74	1.94	2.04	2.16	2.37	

EN 12900 Household (CECOMAF) 220V, 60Hz, fan cooling F₁

Evap. temp. in °C	-45	-40	-35	-30	-25	-23.3	-20	-15	-10	-6.7	-5	0	5	7.2	10	15	20
Capacity in W			77	123	179	200	245	325	420	492	532	664	818	893			
Power cons. in W			110	149	188	202	228	269	311	339	353	395	437	456			
Current cons. in A			1.22	1.33	1.45	1.49	1.58	1.72	1.86	1.97	2.02	2.19	2.37	2.45			
COP in W/W			0.69	0.83	0.95	0.99	1.07	1.21	1.35	1.45	1.51	1.68	1.87	1.96			

ASHRAE MBP 220V, 50Hz, fan cooling F₁

Evap. temp. in °C	-45	-40	-35	-30	-25	-23.3	-20	-15	-10	-6.7	-5	0	5	7.2	10	15	20
Capacity in W							235	305	390	455	491	610	749	818	912	1099	
Power cons. in W							208	234	260	278	288	317	348	362	381	417	
Current cons. in A							1.84	1.88	1.92	1.96	1.98	2.06	2.19	2.27	2.38	2.64	
COP in W/W							1.13	1.30	1.50	1.63	1.71	1.93	2.16	2.26	2.39	2.64	

ASHRAE MBP 220V, 60Hz, fan cooling F₁

Evap. temp. in °C	-45	-40	-35	-30	-25	-23.3	-20	-15	-10	-6.7	-5	0	5	7.2	10	15	20
Capacity in W			86	173	198	222	272	359	463	542	587	732	902	985			
Power cons. in W			112	149	188	202	228	269	310	337	351	393	435	453			
Current cons. in A			1.22	1.33	1.45	1.49	1.58	1.71	1.86	1.96	2.02	2.18	2.36	2.44			
COP in W/W			0.77	0.92	1.05	1.10	1.19	1.34	1.50	1.61	1.68	1.87	2.08	2.18			

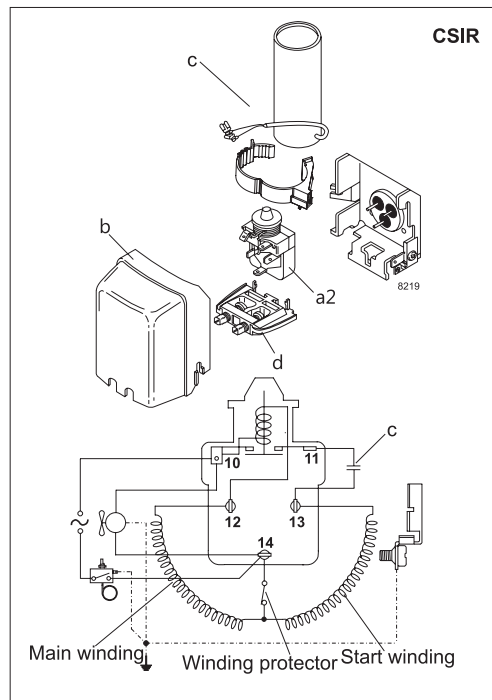
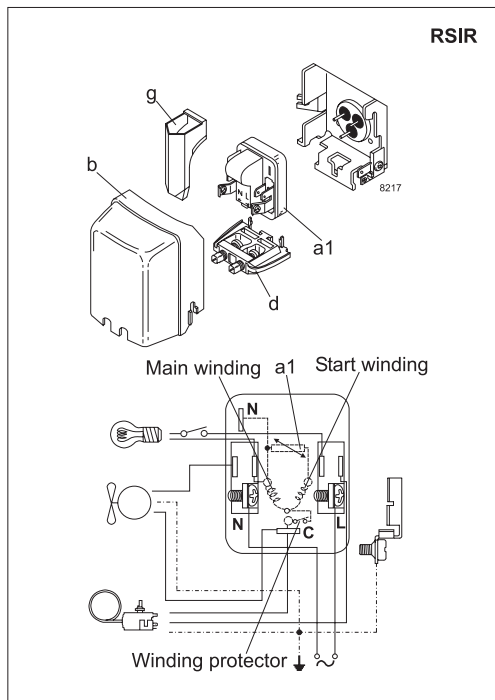

Accessories for	NL8.4MF	Figure	Code number
PTC starting device	6.3 mm spade connectors	a1	103N0011
	4.8 mm spade connectors		103N0018
Starting relay	6.3 mm spade connectors	a2	117U6016
Start. capacitor 80 µF	6.3 mm spade connectors	c	117U5015
Cover		b	103N2011
Cord relief		d	103N1010
Protection screen for PTC		g	103N0476

Test conditions	EN 12900/CECOMAF	ASHRAE
Condensing temperature	55°C	54.4°C
Ambient temperature	32°C	35°C
Suction gas temperature	32°C	35°C
Liquid temperature	no subcooling	46.1°C

Mounting accessories		Code number
Bolt joint for one comp.	Ø: 16 mm	118-1917
Bolt joint in quantities	Ø: 16 mm	118-1918
Snap-on in quantities	Ø: 16 mm	118-1919

Secop accepts no responsibility for possible errors in catalogs, brochures, and other printed material. Secop reserves the right to alter its products without notice. This also applies to products already on order provided that such alterations can be made without substantial changes being necessary to specifications already agreed. All trademarks in this material are the property of the respective companies. Secop and the Secop logotype are trademarks of Secop GmbH. All rights reserved. www.secop.com