

## NL9F Standard Compressor R134a 220-240V 50Hz

### General

Code number	105G6802
Approvals	EN 60335-2-34 with Annex AA
Compressors on pallet	80

### Application

Application	LBP		
Frequency	Hz	50	60
Evaporating temperature	°C	-35 to -10	-
Voltage range	V	198 - 254	-
Max. condensing temperature continuous (short)	°C	60 (70)	-
Max. winding temperature continuous (short)	°C	125 (135)	-

### Cooling requirements

Frequency	Hz	50			60		
Application		LBP	MBP	HBP	LBP	MBP	HBP
32°C		S	-	-	-	-	-
38°C		S	-	-	-	-	-
43°C		-	-	-	-	-	-
Remarks on application:							

### Motor

Motor type	RSIR/CSIR		
LRA (rated after 4 sec. UL984), HST   LST	A	7.9	6.6
Cut in Current, HST   LST	A	7.9	10.9
Resistance, main   start winding (25°C)	Ω	10.7	13.0

### Design

Displacement	cm <sup>3</sup>	8.35
Oil quantity (type)	cm <sup>3</sup>	320 (polyolester)
Maximum refrigerant charge	g	400
Free gas volume in compressor	cm <sup>3</sup>	2280
Weight without electrical equipment	kg	10.0

### Dimensions

Height	mm	A	197
		B	191
		B1	-
		B2	-
Suction connector	location/I.D. mm   angle	C	8.2   15°
	material   comment		Copper   Rubber plug
Process connector	location/I.D. mm   angle	D	6.2   25°
	material   comment		Copper   Rubber plug
Discharge connector	location/I.D. mm   angle	E	6.2   35°
	material   comment		Copper   Rubber plug
Oil cooler connector	location/I.D. mm   angle	F	-
	material   comment		-
Connector tolerance	I.D. mm		±0.09
Remarks:			

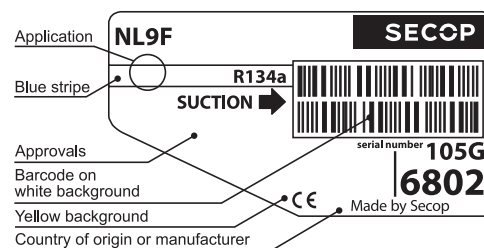

- S = Static cooling normally sufficient
- O = Oil cooling
- F<sub>1</sub> = Fan cooling 1.5 m/s  
(compressor compartment temperature equal to ambient temperature)
- F<sub>2</sub> = Fan cooling 3.0 m/s necessary
- SG = Suction gas cooling normally sufficient
- = not applicable in this area

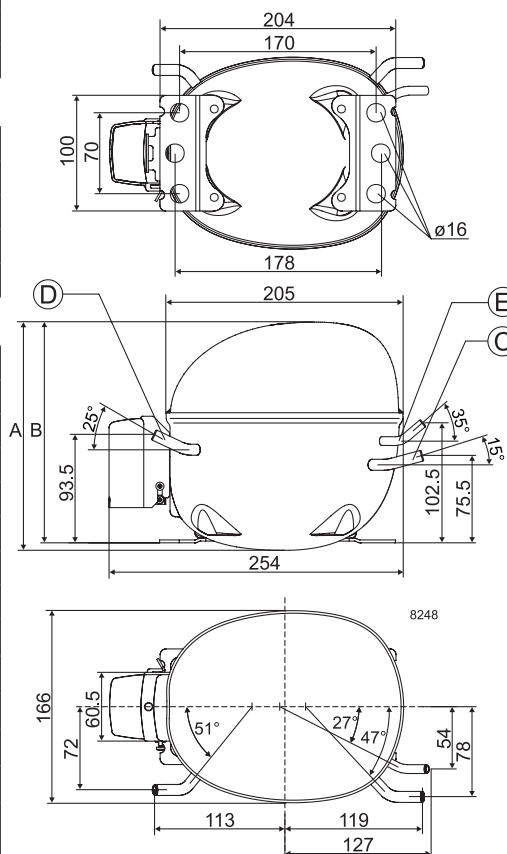

**EN 12900 Household (CECOMAF)** 220V, 50Hz, static cooling

Evap. temp in °C	-45	-40	-35	-30	-25	-23.3	-20	-15	-10	-6.7	-5	0	5	7.2	10	15	20
Capacity in W			74	111	155	172	207	268	340								
Power cons. in W			109	139	167	176	195	226	260								
Current cons. in A			0.89	0.97	1.07	1.11	1.18	1.29	1.42								
COP in W/W			0.68	0.80	0.93	0.97	1.06	1.19	1.31								

**ASHRAE LBP** 220V, 50Hz, static cooling

Evap. temp in °C	-45	-40	-35	-30	-25	-23.3	-20	-15	-10	-6.7	-5	0	5	7.2	10	15	20
Capacity in W			92	138	192	213	256	332	421								
Power cons. in W			110	139	167	176	195	225	259								
Current cons. in A			0.89	0.97	1.07	1.10	1.18	1.29	1.41								
COP in W/W			0.84	0.99	1.15	1.21	1.32	1.48	1.63								



Accessories for	NL9F	Figure	Code number
PTC starting device	6.3 mm spade connectors	a1	103N0011
	4.8 mm spade connectors		103N0018
Starting relay	6.3 mm spade connectors	a2	117U6001
Start capacitor 80 µF	6.3 mm spade connectors	c	117U5015
Cover		b	103N2010
Cord relief		d	103N1010
Protection screen for PTC		g	103N0476

Test conditions	EN 12900/ CECOMAF	ASHRAE
Condensing temperature	55°C	54.4°C
Ambient temperature	32°C	32°C
Suction gas temperature	32°C	32°C
Liquid temperature	no subcooling	32°C

Mounting accessories	Code number	
Bolt joint for one comp.	Ø: 16 mm	118-1917
Bolt joint in quantities	Ø: 16 mm	118-1918
Snap-on in quantities	Ø: 16 mm	118-1919

Nidec GA Compressors accepts no responsibility for possible errors in catalogs, brochures, and other printed material. Nidec GA Compressors reserves the right to alter its products without notice. This also applies to products already on order provided that such alterations can be made without subsequential changes being necessary to specifications already agreed. All trademarks in this material are the property of the respective companies. Secop and the Secop logotype are trademarks of Nidec Global Appliance Germany GmbH. All rights reserved. [www.secop.com](http://www.secop.com)