

## SC10CLX LBP/MBP Compressor R404A/R507 220-240V 50/60Hz

### General

Code number	104L2536
Approvals	UL984, CCC, KC
Compressors on pallet	80

### Application

Application	LBP/MBP			
	Hz	50	60	
Frequency	Hz	50	60	
Evaporating temperature	°C	-35 to 5	-35 to -5	
Voltage range	V	198 - 254	198 - 254	
Max. condensing temperature continuous (short)	°C	50 (60)	50 (60)	
Max. winding temperature continuous (short)	°C	125 (135)	125 (135)	

### Cooling requirements

Frequency	Hz	50			60		
		LBP	MBP	HBP	LBP	MBP	HBP
32°C		F <sub>2</sub>	F <sub>2</sub>	-	F <sub>2</sub>	F <sub>2</sub>	-
38°C		F <sub>2</sub>	F <sub>2</sub>	-	F <sub>2</sub>	F <sub>2</sub>	-
43°C		-	-	-	-	-	-
Remarks on application:							

### Motor

Motor type	CSIR		
LRA (rated after 4 sec. UL984), HST   LST	A	14.8	-
Cut in Current, HST   LST	A	14.8	-
Resistance, main   start winding (25°C)	Ω	5.0	13.7

### Design

Displacement	cm <sup>3</sup>	10.29
Oil quantity (type)	cm <sup>3</sup>	500 (polyolester)
Maximum refrigerant charge	g	1300
Free gas volume in compressor	cm <sup>3</sup>	1460
Weight without electrical equipment	kg	13.1

### Dimensions

Height	mm	A	209
		B	203
		B1	183
		B2	100
Suction connector	location/I.D. mm   angle	C	8.2   37°
	material   comment	Copper   Rubber plug	
Process connector	location/I.D. mm   angle	D	6.5   37°
	material   comment	Copper   Rubber plug	
Discharge connector	location/I.D. mm   angle	E	6.5   37°
	material   comment	Copper   Rubber plug	
Oil cooler connector	location/I.D. mm   angle	F	-
	material   comment	-	
Connector tolerance	I.D. mm	±0.09	
Remarks:			

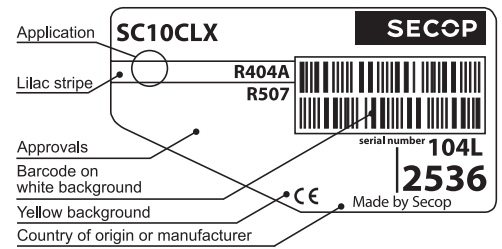

- S = Static cooling normally sufficient
- O = Oil cooling
- F<sub>1</sub> = Fan cooling 1.5 m/s  
(compressor compartment temperature equal to ambient temperature)
- F<sub>2</sub> = Fan cooling 3.0 m/s necessary
- SG = Suction gas cooling normally sufficient
- = not applicable in this area

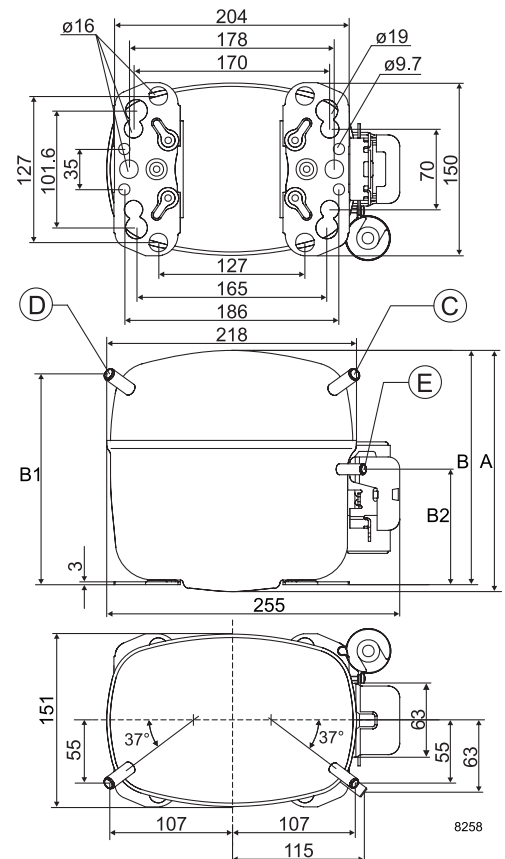

**ASHRAE LBP\***

 230V, 60Hz, fan cooling F<sub>2</sub>

Evap. temp. in °C	-45	-40	-35	-30	-25	-23.3	-20	-15	-10	-6.7	-5	0	5	7.2	10	15	20
Capacity in W			274	399	537	587	690	862	1057	1200	1279						
Power cons. in W			312	374	430	449	487	547	617	670	700						
Current cons. in A			2.21	2.37	2.55	2.62	2.76	3.00	3.27	3.46	3.57						
COP in W/W			0.88	1.07	1.25	1.31	1.42	1.57	1.71	1.79	1.83						

**ASHRAE LBP\***

 220V, 50Hz, fan cooling F<sub>2</sub>

Evap. temp. in °C	-45	-40	-35	-30	-25	-23.3	-20	-15	-10	-6.7	-5	0	5	7.2	10	15	20
Capacity in W			202	306	428	474	571	738	930	1071	1149	1399	1682				
Power cons. in W			260	304	353	370	404	455	503	533	548	585	614				
Current cons. in A			2.01	2.16	2.32	2.38	2.50	2.70	2.92	3.08	3.16	3.42	3.69				
COP in W/W			0.78	1.01	1.21	1.28	1.42	1.62	1.85	2.01	2.10	2.39	2.74				

**EN 12900 Household (CECOMAF)**

 230V, 60Hz, fan cooling F<sub>2</sub>

Evap. temp. in °C	-45	-40	-35	-30	-25	-23.3	-20	-15	-10	-6.7	-5	0	5	7.2	10	15	20
Capacity in W			224	335	455	499	588	738	906	1028	1096						
Power cons. in W			304	370	430	450	489	552	623	677	707						
Current cons. in A			2.19	2.36	2.55	2.62	2.77	3.02	3.30	3.50	3.61						
COP in W/W			0.74	0.90	1.06	1.11	1.20	1.34	1.45	1.52	1.55						

**EN 12900 Household (CECOMAF)**

 220V, 50Hz, fan cooling F<sub>2</sub>

Evap. temp. in °C	-45	-40	-35	-30	-25	-23.3	-20	-15	-10	-6.7	-5	0	5	7.2	10	15	20
Capacity in W			166	255	360	400	483	625	789	910	977	1190	1430				
Power cons. in W			258	302	352	369	404	457	508	540	556	597	631				
Current cons. in A			2.00	2.15	2.32	2.38	2.51	2.72	2.94	3.10	3.19	3.45	3.73				
COP in W/W			0.64	0.84	1.02	1.08	1.20	1.37	1.55	1.68	1.76	1.99	2.27				

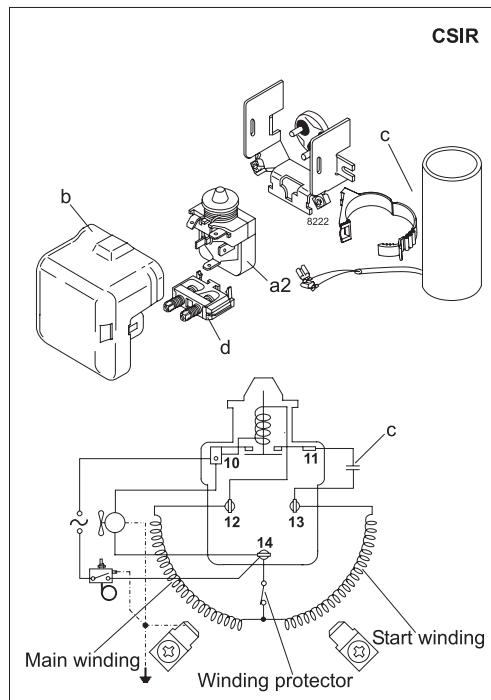

Accessories for	SC10CLX	Figure	Code number	Test conditions	EN 12900/CECOMAF	ASHRAE LBP*
PTC starting device	6.3 mm spade connectors	a1	–	Condensing temperature	45°C	43.3°C
	4.8 mm spade connectors		–	Ambient temperature	32°C	32°C
Starting relay	6.3 mm spade connectors	a2	117U6005	Suction gas temperature	32°C	32°C
Cover		b	103N2008	Liquid temperature	no subcooling	32°C
Start. capacitor 80 µF	6.3 mm spade connectors	c	117U5017			
Cord relief		d	103N1004			
Protection screen for PTC		g	–			
				<b>Mounting accessories</b>	<b>Code number</b>	
				Bolt joint for one comp.	Ø: 16 mm	118-1917
				Bolt joint in quantities	Ø: 16 mm	118-1918
				Snap-on in quantities	Ø: 16 mm	118-1919

Secop accepts no responsibility for possible errors in catalogs, brochures, and other printed material. Secop reserves the right to alter its products without notice. This also applies to products already on order provided that such alterations can be made without consequential changes being necessary to specifications already agreed. All trademarks in this material are the property of the respective companies. Secop and the Secop logotype are trademarks of Secop GmbH. All rights reserved. [www.secop.com](http://www.secop.com)