

TFS4.5FT Tropical Compressor R134a 115-127V 60Hz

General

Code number	102G3432
Approvals	UL984
Compressors on pallet	125

Application

Application	LBP/MBP			
	Hz	50	60	
Frequency	Hz	50	60	
Evaporating temperature	°F	-	-31 to 45	
Voltage range	V	-	95 - 135	
Max. condensing temperature continuous (short)	°F	-	140 (158)	
Max. winding temperature continuous (short)	°F	-	257 (257)	

Cooling requirements

Frequency	Hz	50			60		
		LBP	MBP	HBP	LBP	MBP	HBP
90°F		-	-	-	F ₁	F ₁	-
100°F		-	-	-	F ₁	F ₁	-
110°F		-	-	-	F ₁	F ₁	-

Remarks on application: In capillary tube systems where non-equalized pressures may occur at compressor start, or in areas with short power supply drop-outs, a starting capacitor can be used for ensuring a successful start (CSIR).

Motor

Motor type	RSIR/CSIR		
LRA (rated after 4 sec. UL984), HST LST	A	-	20.1
Cut in Current, HST LST	A	-	20.1
Resistance, main start winding (77°F)	Ω	3.3	8.8

Design

Displacement	cu.in	0.29
Oil quantity (type)	fl.oz.	9.5 (polyolester)
Maximum refrigerant charge	oz.	14.0
Free gas volume in compressor	fl.oz.	57.3
Weight without electrical equipment	lbs.	14.9

Dimensions

Height	inch	A	6.81
		B	6.65
		B1	-
		B2	-
Suction connector	location, I.D. in. angle	C	0.252-0.259 30°
	material comment		Cu-plated steel Rubber plug
Process connector	location, I.D. in. angle	D	0.252-0.259 31.5°
	material comment		Cu-plated steel Rubber plug
Discharge connector	location, I.D. in. angle	E	0.193-0.198 28°
	material comment		Cu-plated steel Rubber plug
Oil cooler connector	location, I.D. in. angle	F	-
	material comment		-
Remarks:			

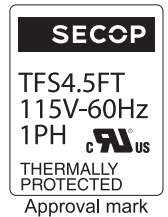
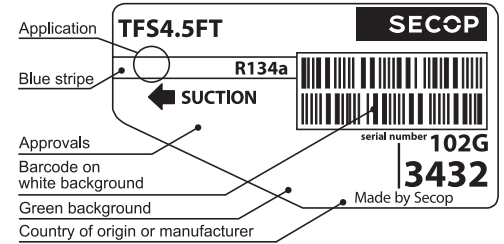

- S = Static cooling normally sufficient
- O = Oil cooling
- F₁ = Fan cooling 1.5 m/s (compressor compartment temperature equal to ambient temperature)
- F₂ = Fan cooling 3.0 m/s necessary
- SG = Suction gas cooling normally sufficient
- = not applicable in this area

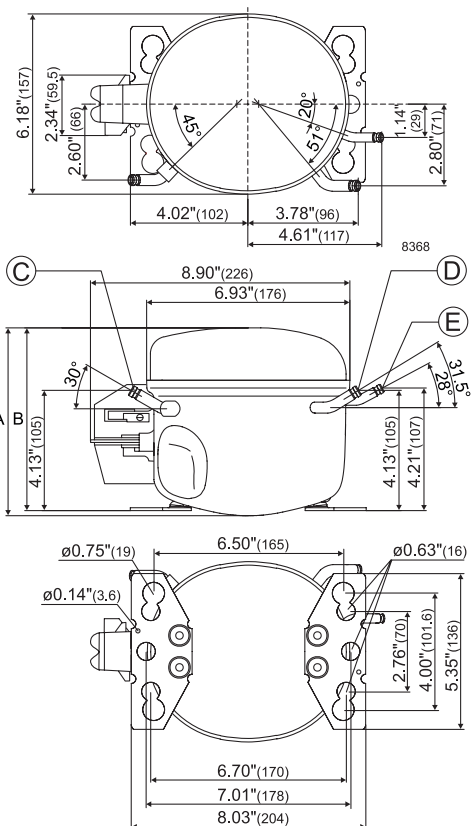

ASHRAE LBP

115V, 60Hz, static cooling

Evap. temp. in °F	-49	-40	-30	-20	-13	-10	0	10	14	20	30	40	41	45	50	59	68
Capacity in BTU/h			245	340	431	477	654	875	974	1135	1445	1793	1835	1987			
Power cons. in W			90	108	121	127	148	172	182	197	225	254	257	270			
Current cons. in A			1.88	1.94	1.99	2.02	2.12	2.25	2.31	2.41	2.60	2.83	2.86	2.96			
EER in BTU/Wh			2.72	3.16	3.56	3.75	4.40	5.09	5.36	5.76	6.43	7.06	7.14	7.37			

EN 12900 Household (CECOMAF)

115V, 60Hz, static cooling

Evap. temp. in °F	-49	-40	-30	-20	-13	-10	0	10	14	20	30	40	41	45	50	59	68
Capacity in W			58	80	102	113	155	208	231	269	343	425	435	471			
Power cons. in W			90	108	121	127	148	172	182	197	225	254	258	270			
Current cons. in A			1.88	1.94	1.99	2.02	2.12	2.25	2.31	2.41	2.60	2.83	2.86	2.96			
COP in W/W			0.64	0.75	0.84	0.89	1.04	1.21	1.27	1.37	1.52	1.67	1.69	1.74			

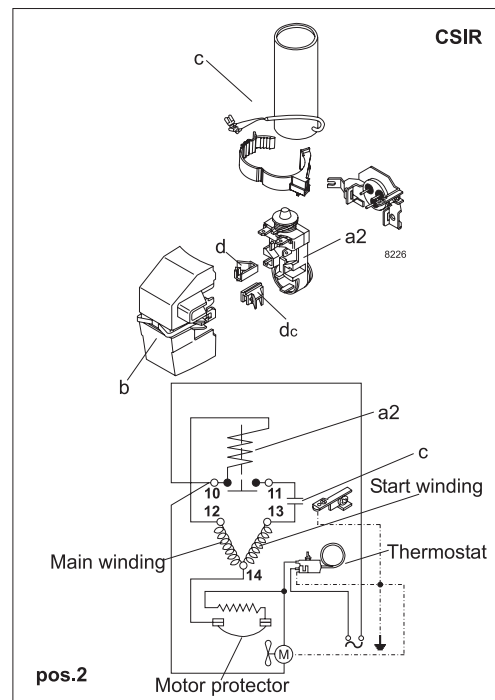
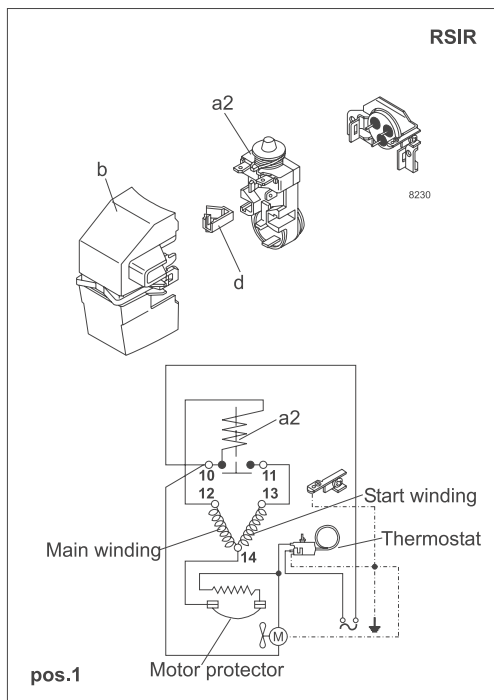

Accessories for TFS4.5FT	Figure	Code number
Starting relay (protector incl.)	a2	117U4113
Protector 3/4 in. Texas Instruments	(pos.1)	MRP39AIL-6
Starting relay (protector incl.)	a2	117U4126
Protector 3/4 in. Texas Instruments	(pos.2)	MRP39AIL-6
Start. capacitor 320 µF	c	117U5022
Cover	b	117U1021
Cord relief	d	117U0349
Cord relief capacitor	dc	117U0349

Test conditions	ASHRAE LBP	EN 12900/CECOMAF
Condensing temp.	130°F	131°F
Ambient temp.	90°F	90°F
Suction gas temp.	90°F	90°F
Liquid temperature	90°F	131°F

Mounting accessories	Code number
Bolt joint for one comp. Ø: 5/8 in.	118-1917
Bolt joint in quantities Ø: 5/8 in.	118-1918
Snap-on in quantities Ø: 5/8 in.	118-1919

Secop accepts no responsibility for possible errors in catalogs, brochures, and other printed material. Secop reserves the right to alter its products without notice. This also applies to products already on order provided that such alterations can be made without consequential changes being necessary to specifications already agreed. All trademarks in this material are the property of the respective companies. Secop and the Secop logotype are trademarks of Secop GmbH. All rights reserved. www.secop.com