

NEW BATTERY-DRIVEN SOLUTION – SMALLER AND MORE EFFICIENT

SECCP



BD Nano-Series



VARIABLE
SPEED EFFICIENCY

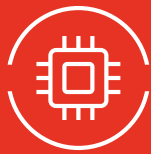

PREMIUM
CONTROLLERS



LOW GWP
REFRIGERANTS



LOW NOISE
LOW VIBRATION



SMALL
FOOTPRINT



MOBILE
APPLICATIONS

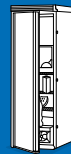

- **Compact Size**
Even more compact than a BD Micro compressor for more capacity in the cabinet
- **Robust Design for Mobile Applications**
Reduced knocking and improved stability during transport
- **Protection Against Electromagnetic Interference (EMI)**
Designed for reduced emissions and increased immunity against external sources
- **Tailor-Made Configurations**
Optimized hardware/software for recreational and automotive applications
- **Premium High Efficiency**
Greater energy savings, reduced total cost of ownership (TCO), and extending battery operation time
- **Extended Cooling Capacity**
Replaces larger compressors, thereby extending the range of applications
- **Reduced Noise and Vibrations**
Improved acoustic comfort for noise-sensitive applications
- **Multiple Compliance Options**
Regulatory compliance and environmentally friendly R1234yf or R600a refrigerants

Secop's latest innovation for mobile refrigeration is the new **BD Nano** compressor which is available for low GWP refrigerants R600a and R1234yf as well as for R134a.

This compact very low vibrating low noise emitting compressor is the ideal solution for small and silent cooling units. Together with its premium controller, this highly efficient mobile direct current compressor preserves battery life during cooling.

Compared to its predecessor models, the **BD Nano** offers enhanced connectivity and lower EMI, thus making it easier for our customers to meet the stringent standards for equipment approvals, they also achieve a lower TCO.

The extreme compact **BD Nano** (40% shorter, 67% lighter in comparison – controller included) provides the same cooling capacity as much bigger BD35F/50F/35K compressors yet with unrivaled efficiency.

The **BD Nano** features some technical innovations such as a new mobile stability concept, an improved lubrication concept, miniaturized new mufflers, a compact housing, a miniaturized new motor, improved valves, and compact versatile controllers, among other things.

An innovative robust design based on years of mobile compressor development expertise.

THREE GENERATIONS OF SECOP BD COMPRESSORS IN COMPARISON

COMPRESSOR	Refrigerant	Application	Displacement [cm³]	Capacity ASHRAE LBP [W]	COP ASHRAE LBP [W/W]	Speed range [rpm]	Compressor + controller height [mm]	Compressor + controller weight [kg]
BDN45F	R134a/R1234yf	LBP/MBP	1.4	60.7	1.52	2300-4500	82.4	1.5
BD1.4F-VSD.3	R134a/R1234yf	LBP/MBP/HBP	1.4	34.0	0.94	2000-4000	91.3	2.3
BD35F	R134a	LBP/MBP/HBP	2.0	50.5	1.15	2000-3500	135	4.5
BD50F	R134a	LBP/MBP/HBP	2.5	71.6	1.18	2000-3500	135	4.5
BDN50K	R600a	LBP/MBP	2.6	68.5	1.52	2300-4500	82.4	1.5
BD35K	R600a	LBP/MBP/HBP	3.0	49.0	1.13	2000-3500	135	4.5
BD50K	R600a	LBP/MBP/HBP	3.0	57.2	1.08	2500-4400	135	4.5

Test conditions: Evaporating temp: -23.3°C | Condensing temp. 54.4°C | Suction gas temp. 32.2°C | Ambient temp. 32.2°C | Liquid temp. 32.2°C | Max. speed

SMALL FOOTPRINT

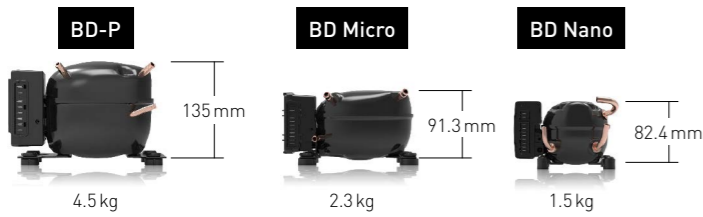

EFFECTIVE SOLUTIONS

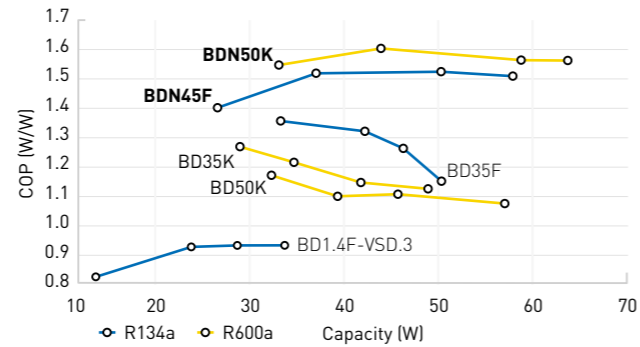

SECOP BD NANO VS. BD-P, BD MICRO @ ASHRAE LBP

R134a - PERFORMANCE

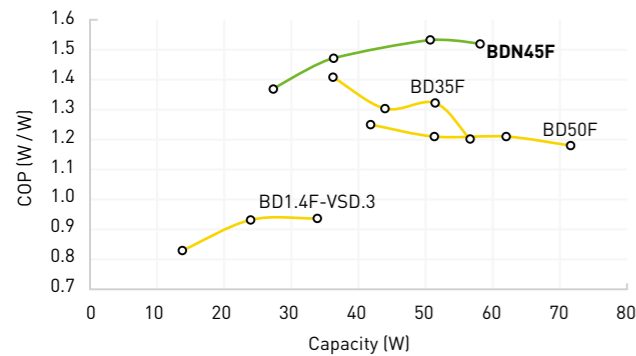

R600a - PERFORMANCE

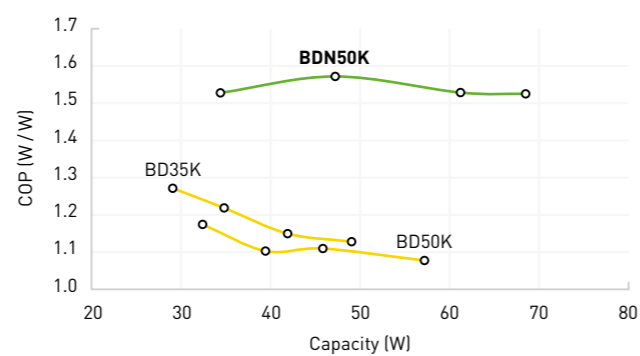

R134a - NOISE

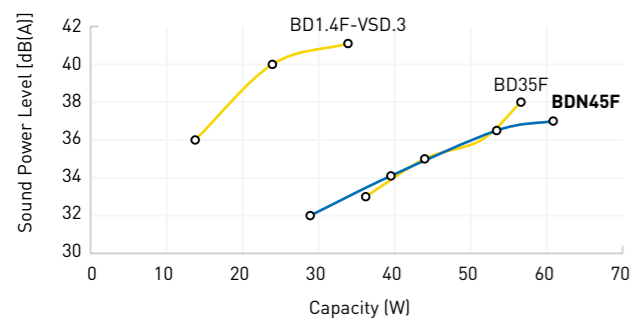

R600a - NOISE

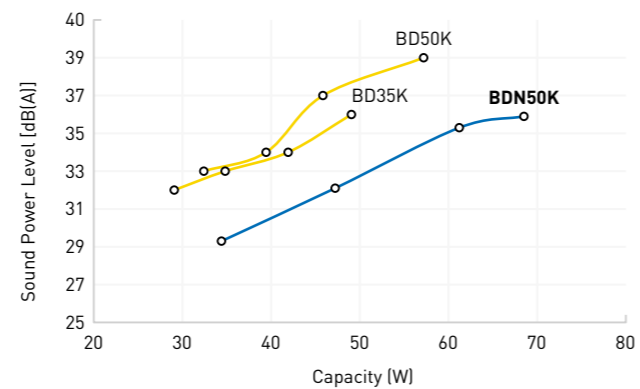

GENERAL	BDN45F	BDN50K
Refrigerant	R134a, R1234yf	R600a
Compressor (1.37 kg)	109Z0400	109Z0420
Electronic unit (0.14 kg)	101N2740	101N2740
Approvals	UL, CB	UL, CB

APPLICATION		
Application	LBP/MBP	
Evaporating temperature	°C	-30 to 5
Voltage range	VDC	9.6-17 / 19-34
Speed range	rpm	2300-4500

PERFORMANCE DATA ASHRAE LBP [12 V DC • static cooling] @ -23.3°C evaporating temperature									
Speed	rpm	2300	3000	4000	4500	2300	3000	4000	4500
Cooling capacity	W	27.6	36.6	51.1	58.7	34.4	47.2	61.2	68.5
Power consumption	W	20.0	24.8	33.5	38.7	22.6	30.0	40.1	45.0
COP	W/W	1.37	1.47	1.53	1.52	1.52	1.57	1.53	1.52
Test conditions	Condensing temperature: 54.4°C Suction gas temperature: 32.2°C Ambient temperature: 32.2°C Liquid temperature: 32.2°C BDN45F performance data measured with R134a (R1234yf values similar)								

PERFORMANCE DATA EN 12900 Household /CECOMAF [12 V DC • static cooling] @ -25°C evaporating temperature									
Speed	rpm	2300	3000	4000	4500	2300	3000	4000	4500
Cooling capacity	W	19.9	26.2	36.6	42.0	25.6	35.2	45.4	50.8
Power consumption	W	19.0	23.3	31.3	36.1	21.5	28.5	37.9	42.5
COP	W/W	1.05	1.13	1.17	1.16	1.19	1.23	1.20	1.19
Test conditions	Condensing temperature: 55°C Suction gas temperature: 32°C Ambient temperature: 32°C Liquid temperature: no subcooling BDN45F performance data measured with R134a (R1234yf values similar)								

DIMENSIONS			
Height	mm	A	89.0
		B / B1 / B2	82.4 / 48.7 / 45.8
Suction connector	location/I.D. mm angle material seal	C	6.2 5° Copper Rubber plug
Process connector	location/I.D. mm angle material seal	D	6.2 77.9° Copper Rubber plug
Discharge connector	location/I.D. mm angle material seal	E	5.0 86.9° Cu-plated steel Rubber plug
Connector tolerance	I.D. mm		±0.09, on 5.0 +0.12/+0.20

ELECTRONIC UNIT FEATURES	
New 32-bit microcontroller STM32	Parameters accessible in SI units · quicker response times · class B software for easier CB approval
Dedicated fan converter hardware	Stable fan output voltage · no fan noise changes · perfect fan protection
LIN communication hardware	Standard transceivers · robust against ground voltage shift and EMI · Modbus protocol
Updated hardware design and components	Minimal additional EMI filtering required · state of the art components · long term availability
Improved housing design	Optimized airflow · optimized PCB position · enforced stability for protection against rough conditions
Coded connectors with RAST hook	Withstand high pull forces · prevent miss-insertion · smart grouping eases wiring
Easier mounting	Fixed motor connector (snap on) · one-hand mounting without screwdriver · optional screw

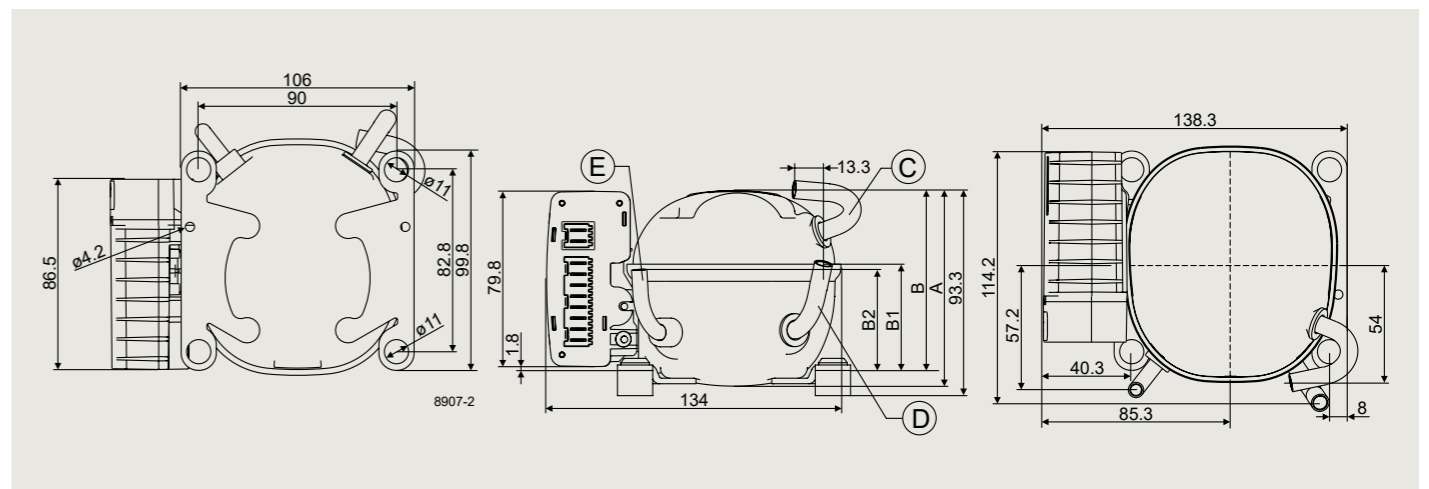



Tool4Cool® SOFTWARE INTERFACE

Tool4Cool® is a unique PC software tool that enables you to precisely configure your Secop BD compressors to your cooling systems.

Via microprocessor-based controllers, Tool4Cool® gives you easy access to all parameters. These can be changed, monitored, downloaded or uploaded to get the optimum performance out of your cooling system.

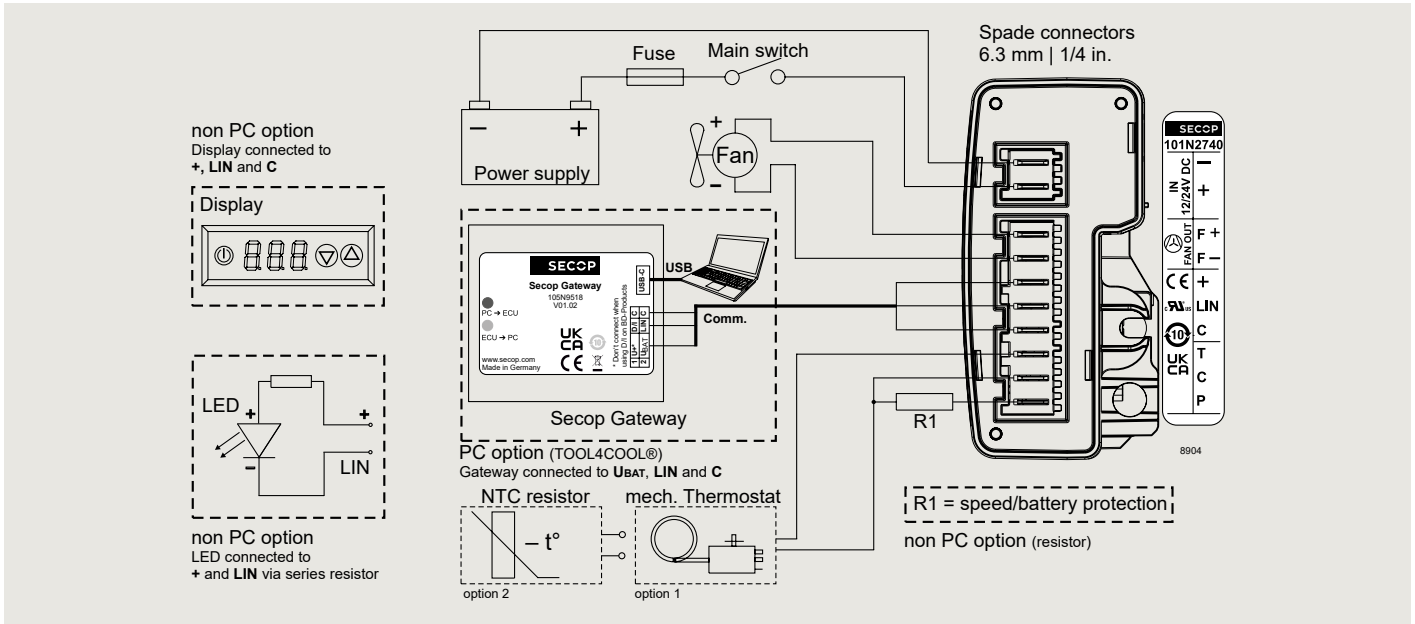

SECOP MOBILE COOLING

DC-powered or battery-driven compressors specifically designed for mobile cooling solutions: automotive (trucks, cars, bus), recreations vehicles, portable boxes, medical, solar, and special applications

Series	Displacement (cm³)	Cooling Capacity			Refrigerants
		LBP (W) ASHRAE	MBP (W) ASHRAE	HBP (W) ASHRAE	
BD Nano	1.42 - 2.60	29 - 69	63 - 135		R134a R1234yf R600a
BD Micro	1.41	13 - 34	42 - 94	83 - 173	R134a R1234yf
BD-P	2.0 - 3.0	29 - 71	65 - 223	115 - 390	R600a R290 R134a
BD-T	3.86 - 5.08	115 - 245	242 - 473	433 - 804	R134a R404A

0 - 35 0 - 2000 0 - 3500 0 - 2750

Secop mobile cooling compressors are available for a variety of DC voltage ranges and certain controllers even feature an AC option for various mains supply.



Secop GmbH · Lise-Meitner-Str. 29 · 24941 Flensburg, Germany · Tel: +49 461 4941 0 · www.secop.com

Secop accepts no responsibility for possible errors in catalogs, brochures, and other printed material. Secop reserves the right to alter its products without notice. This also applies to products already on order provided that such alterations can be made without subsequent changes being necessary to specifications already agreed. All trademarks in this material are the property of the respective companies. Secop and the Secop logotype are trademarks of Secop GmbH. All rights reserved.