

Single Pack HXK95AT 200-240V 50Hz 208-230V 60Hz RSCR

Single pack code number: **195B4823**

Position	Title	Code	Amount
1	Compressor HXK95AT	16438100	1
2	Terminal board 4.8mm	16403800	1
3	Run capacitor (4 μ F 420V, 4.8mm)	11261700	1
4	Screw for cable clamp	10636000	1
5	Screw for cable clamp	10636200	1
6	Cable clamp	16058100	1
7	Cover	10636401	1
8	Earth screw	10641201	1
9	Clip	10633900	4
10	Steel pin	10634100	4
11	Washer	10634300	4
12	Rubber grommet 16mm	11322600	1

Secop GmbH • Lise-Meitner-Straße 29 • 24941 Flensburg, Germany • Tel: +49 461 4941 0 • www.secop.com

Secop accepts no responsibility for possible errors in catalogs, brochures, and other printed material. Secop reserves the right to alter its products without notice. This also applies to products already on order provided that such alterations can be made without subsequent changes being necessary to specifications already agreed. All trademarks in this material are the property of the respective companies. Secop and the Secop logotype are trademarks of Secop GmbH. All rights reserved.

Model

Designation	HXK95AT	200-240V/50Hz 1~ 208-230V/60Hz 1~	Sales code:	16438100
-------------	----------------	-----------------------------------	-------------	-----------------

Compressor design

Oil type	Mineral	Refrigerant(s)	R600a
Oil viscosity	5cSt	Displacement	9,6cm ³ / 0,59cu.in
Oil quantity	162cm ³ / 5,5fl.oz	Compressors on pallet	100
Refr. charge - tech. limit	150g / 5,3oz		
Free gas volume comp.	1560cm ³ / 52,7fl.oz		
Weight	8,6kg / 19lbs		
Motor protection	external		
Winding resistance main	15,5Ω (at 25°C)		
Winding resistance aux	9,9Ω (at 25°C)		
Max. winding temp.	130°C / 266°F		
Max. discharge temp.	130°C / 266°F		



General - Configurations with HXK95AT

	Conf. 1	Conf. 2	Conf. 3	Conf. 4
Motor configuration	RSCR	RSIR	RSCR	RSCR
Power supply (nominal)	200-240V/50Hz	200-240V/50Hz	220-240V/50Hz	208-230V/60Hz
Number of phases	1	1	1	1
Voltage range	170-264V	170-264V	170-264V	198-253V
Approvals	VDE	VDE	VDE	VDE
Starting torque	LST	LST	LST	LST
Note	Various options of connectors are possible - please contact SECOP-Sales.			

Applications with HXK95AT

	Conf. 1	Conf. 2	Conf. 3	Conf. 4
Refrigerant	R600a	R600a	R600a	R600a
Application	LBP	LBP	LBP	LBP
System cooling	static	static	static	static
Hot gas defrost	-/-	-/-	-/-	-/-
Long interval pull down	-/-	-/-	-/-	-/-

Electrical data - Configurations with HXK95AT

	Conf. 1	Conf. 2	Conf. 3	Conf. 4
Starting device type	PTC	PTC	PTC	PTC
Run capacitor	4μF	-/-	4μF	4μF
Start capacitor	-/-	-/-	-/-	-/-
LRA (locked rotor amps / 4s/ U(N))			6A	6A
RLA (rated load amps / 1s/ U(N))	-/-A	-/-A	0,55A	0,55A
Cut in current (U(N))			13,1A	13,7A

Model

Designation **HXK95AT** 200-240V/50Hz 1~ 208-230V/60Hz 1~ Sales code: **16438100**

Compressor dimensions

Housing	A Height	174mm / 6,85in
	B Height	167mm / 6,57in
	C Length shell	194mm / 7,64in
	D Length w. cover	238mm / 9,37in
	E Width	151mm / 5,94in

Connectors	Suction	Discharge	Process	
	X	Y	Z	
Diameter [mm]	øi 6,1-6,2	øi 5,1-5,2	øo 5,92-6,08	
(i:inside, o:outside) [in]	øi 0,24-0,24	øi 0,2-0,2	øo 0,23-0,24	
Material	copper	copper	copper	
Horizontal angle	±2° 45°	13°	0°	
Vertical angle	±2° 30°	40°	145°	
Position l/h/w	[mm]	120/72/62	112/106/62	-140/136/70
	[in]	4,7/2,8/2,4	4,4/4,2/2,4	-5,5/5,4/2,8
Straight tube l.	[mm]	14	14	75
	[in]	0,5	0,5	3

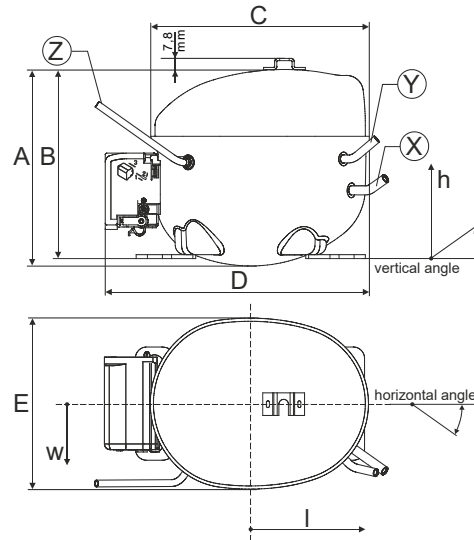

Compressor fixation

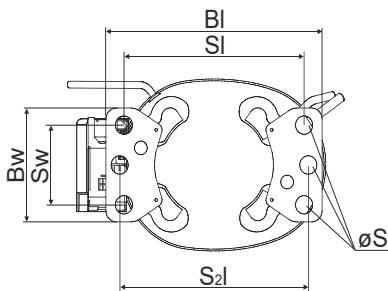

Baseplate	[mm]	[inch]
BI	204	8.03
Bw	100	3.94
Small holes		
	[mm]	[inch]
SI	170	6.7
Sw	70	2.76
S2l	178	7
øS	ø 16	ø 0.63

Bolt joint

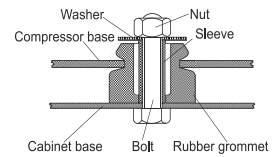

Snap-on

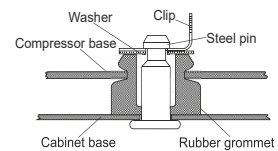

Mounting accessories

- '4ZN' with rubber grommet
- '4ZN' with rubber grommet and sleeve for M6
- Bolt joint kit
- '4ZN' with Snap on kit

- order code
- 772N
 - 768N
 - 4ZN + 118-1917 (18)
 - 776N

Application notes

Provision for PE Grounding is located at the PE Stamp on the compressor Housing with dip-tray fixture (omega bracket).
 Various options of connectors are possible - please contact SECOP-Sales.

Model

Designation **HXK95AT** **200-240V/50Hz** Conf. 1 Sales code: **16438100**

Configuration

Motor configuration RSCR
 Power supply (nominal) 200-240V/50Hz 1~
 Refrigerant R600a
 Application LBP
 Voltage range 170-264V
 Starting torque LST
 Approvals VDE

Electrical accessories / wiring diagram

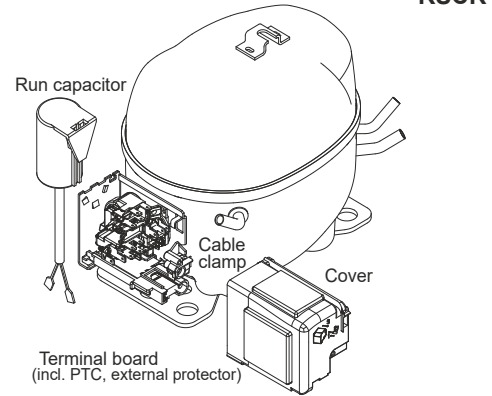

Ambient/ machine room temperatures minimum /maximum

Ambient temperature range: 10 - 43°C / 50 - 110°F
 Machine room temperature range: 10 - 48°C / 50 - 119°F
 Compressor cooling: static

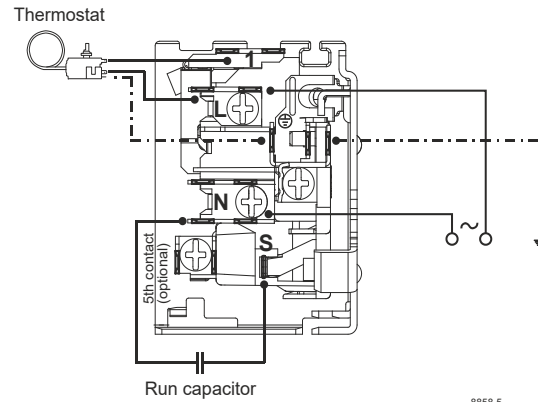

Operation pressure range

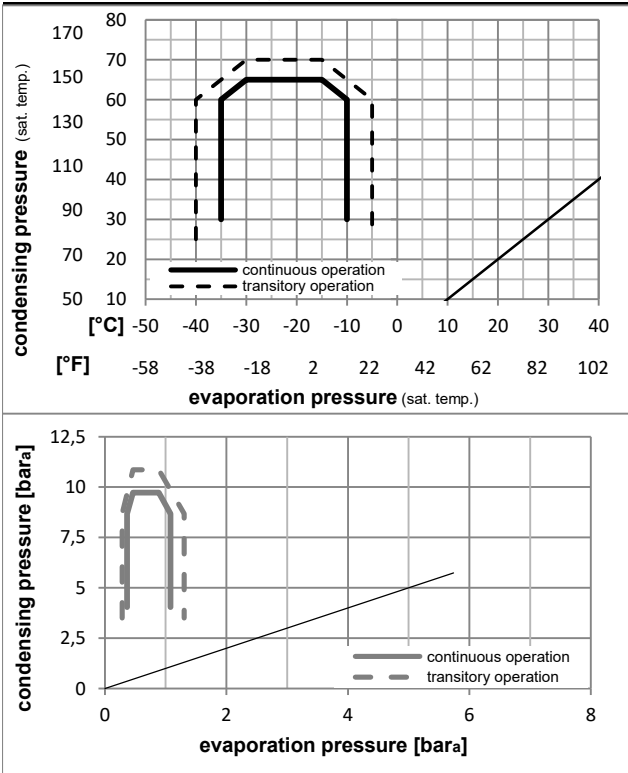

Components

- . terminal board (PTC, 4.8mm) 16403800
- . run capacitor (4μF, 4.8mm) 11261700
- b cover terminal board 10636401
- . cable clamp 16058100
- . screw - uni6954 10636000
- . screw - uni6954 10636200

Alternative components

- . screw uni en iso 4757 10641201

Model

Designation **HXK95AT** **200-240V/50Hz** Conf. 1 Sales code: **16438100**

Optimization + standard conditions

R600a, 200V/50Hz, RSCR, static, VDE

	Evaporating pressure (saturation temperature)				Cooling capacity			COP	EER		Power consumption				
	Condensing pressure (saturation temperature)				Return gas temp.					P1	I	Current consumption		Ref. mass flow	
	pe	pc	RGT	Tliq	[W]	[Btu/h]	[kcal/h]	[W/W]	[Btu/Wh]	[kcal/Wh]	[W]	[A]	m		
[°C]	[°C]	[°C]	[°C]	[W]	[Btu/h]	[kcal/h]	[W/W]	[Btu/Wh]	[kcal/Wh]	[W]	[A]	[kg/h]			
[°C]	-23	54	32	32	173,4	592	149,2	1,75	5,97	1,50	99,2	0,56	1,86		ASHRAE LBP
[°F]	-10	130	90	90											
[°C]	-25	55	32	55	130,1	444	112,0	1,38	4,70	1,18	94,6	0,54	1,70		cecomaf LBP
[°F]	-13	131	90	131											
[°C]	-35	40	20	40	93,8	320	80,8	1,45	4,95	1,25	64,7	0,43	1,14		EN12900 LBP
[°F]	-31	104	68	104											
[°C]	-23	49	4,4	49	139,8	477	120,3	1,45	4,94	1,25	96,6	0,55	2,04		ARI540 LBP
[°F]	-10	120	40	120											
[°C]	-23	41	32	32	179,1	612	154,1	1,95	6,67	1,68	91,7	0,53	1,92		AHAM LBP
[°F]	-10	105	90	90											
[°C]	-35	45	32	45	89,2	305	76,7	1,42	4,85	1,22	62,8	0,42	1,06		opt
[°F]	-31	113	90	113											

Performance tables

R600a, 200V/50Hz, RSCR, static, VDE

	pe		Cooling capacity			COP	EER	P1	I	m	
	[°C]	[°F]	[W]	[Btu/h]	[kcal/h]	[W/W]	[Btu/Wh]	[kcal/Wh]	[W]	[A]	[kg/h]
[°C / °F]	-35	-31	89,2	305	76,7	1,42	4,85	1,22	62,8	0,42	1,06
cond. pressure	-30	-22	116,6	398	100,4	1,48	5,05	1,27	78,9	0,48	1,39
pc= 45/113	-25	-13	148,6	507	127,9	1,64	5,59	1,41	90,9	0,53	1,77
return gas temp.	-23	-10	160,8	549	138,4	1,70	5,82	1,47	94,3	0,54	1,92
RGT= 32/90	-20	-4	187,0	639	161,0	1,86	6,35	1,60	100,6	0,56	2,23
liquid temp	-15	5	233,9	799	201,3	2,13	7,27	1,83	109,8	0,60	2,79
Tliq= 45/113	-10	14	291,1	994	250,5	2,42	8,26	2,08	120,3	0,64	3,48
[°C / °F]	-35	-31	60,4	206	52,0	1,10	3,75	0,94	55,1	0,39	0,79
cond. pressure	-30	-22	95,2	325	81,9	1,23	4,19	1,06	77,6	0,47	1,24
pc= 55/131	-25	-13	130,1	444	112,0	1,38	4,70	1,18	94,6	0,54	1,70
return gas temp	-23	-10	142,4	486	122,6	1,43	4,89	1,23	99,5	0,56	1,86
RGT= 32/90	-20	-4	167,3	571	144,0	1,55	5,29	1,33	108,1	0,59	2,19
liquid temp	-15	5	208,5	712	179,5	1,74	5,95	1,50	119,6	0,64	2,73
Tliq= 55/131	-10	14	255,8	874	220,2	1,95	6,67	1,68	131,0	0,69	3,36

Model

Designation	HXK95AT	200-240V/50Hz	Conf. 2	Sales code:	16438100
-------------	----------------	----------------------	----------------	-------------	-----------------

Configuration

Motor configuration	RSIR
Power supply (nominal)	200-240V/50Hz 1~
Refrigerant	R600a
Application	LBP
Voltage range	170-264V
Starting torque	LST
Approvals	VDE

Electrical accessories / wiring diagram

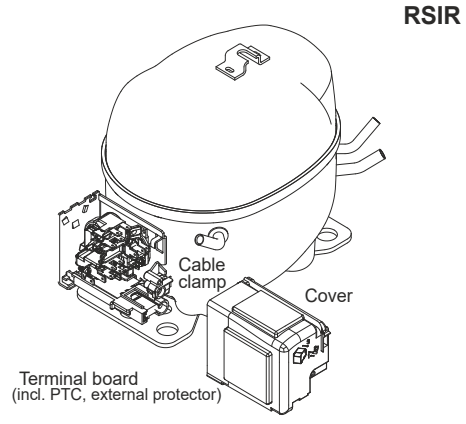

Ambient/ machine room temperatures minimum /maximum

Ambient temperature range:	10 - 43°C / 50 - 110°F
Machine room temperature range:	10 - 48°C / 50 - 119°F
Compressor cooling:	static

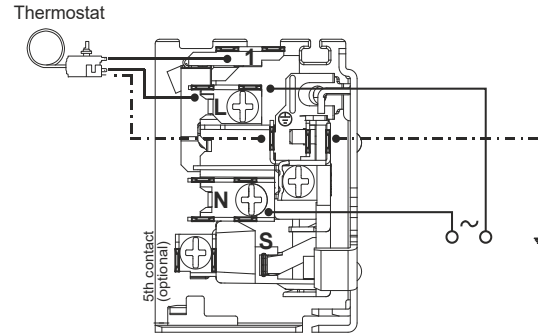

Operation pressure range

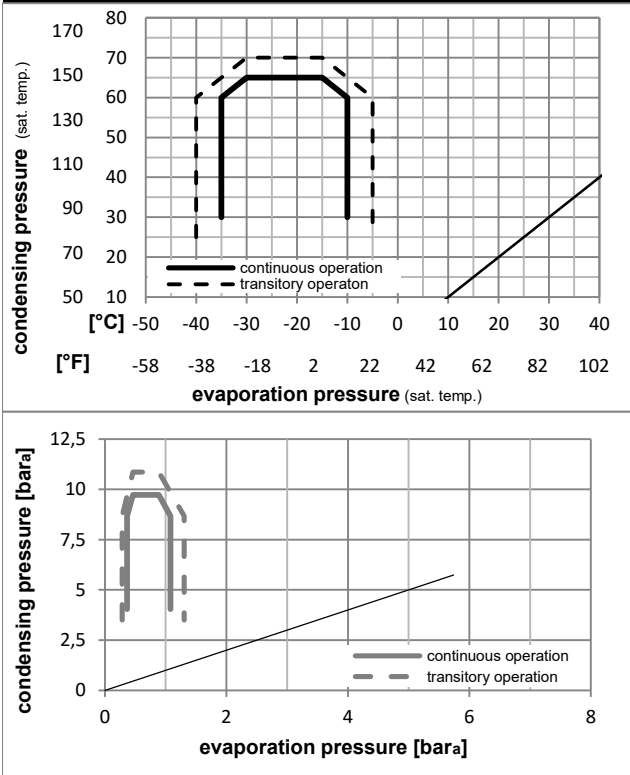

Components

. terminal board (PTC, 4.8mm)	16403800
b cover terminal board	10636401
. cable clamp	16058100
. screw - uni6954	10636000
. screw - uni6954	10636200
. screw uni en iso 4757	10641201

Alternative components

. terminal board (PTC, 6.3mm)	16403600
-------------------------------	----------

Model

Designation **HXK95AT** **200-240V/50Hz** Conf. 2 Sales code: **16438100**

Optimization + standard conditions

R600a, 200V/50Hz, RSIR, static, VDE

	Evaporating pressure (saturation temperature)				Condensing pressure (saturation temperature)			COP	EER	P1	Power consumption		Ref. mass flow	
	pe	pc	RGT	Tliq	[W]	[Btu/h]	[kcal/h]				I	m		
	[°C]	[°F]	[°C]	[°F]	[W]	[Btu/h]	[kcal/h]	[W/W]	[Btu/Wh]	[kcal/Wh]	[W]	[A]	[kg/h]	
ASHRAE LBP	-23	54	32	32	173,4	592	149,2	1,67	5,69	1,44	104,0	0,58	1,86	
	-10	130	90	90										
cecomaf LBP	-25	55	32	55	130,1	444	112,0	1,31	4,48	1,13	99,2	0,57	1,70	
	-13	131	90	131										
EN12900 LBP	-35	40	20	40	93,8	320	80,8	1,38	4,73	1,19	67,8	0,45	1,14	
	-31	104	68	104										
ARI540 LBP	-23	49	4,4	49	139,8	477	120,3	1,38	4,72	1,19	101,2	0,57	2,04	
	-10	120	40	120										
AHAM LBP	-23	41	32	32	179,1	612	154,1	1,86	6,37	1,60	96,1	0,55	1,92	
	-10	105	90	90										
opt	-35	45	32	45	89,2	305	76,7	1,35	4,62	1,17	65,9	0,44	1,06	
	-31	113	90	113										

Performance tables

R600a, 200V/50Hz, RSIR, static, VDE

	pe		Cooling capacity			COP	EER		P1	I	m
	[°C]	[°F]	[W]	[Btu/h]	[kcal/h]	[W/W]	[Btu/Wh]	[kcal/Wh]	[W]	[A]	[kg/h]
[°C / °F]	-35	-31	89,2	305	76,7	1,35	4,62	1,17	65,9	0,44	1,06
cond. pressure	-30	-22	116,6	398	100,4	1,41	4,82	1,21	82,6	0,50	1,39
pc= 45/113	-25	-13	148,6	507	127,9	1,56	5,33	1,34	95,2	0,55	1,77
return gas temp.	-23	-10	160,8	549	138,4	1,63	5,56	1,40	98,9	0,57	1,92
RGT= 32/90	-20	-4	187,0	639	161,0	1,77	6,06	1,53	105,4	0,59	2,23
liquid temp	-15	5	233,9	799	201,3	2,03	6,94	1,75	115,1	0,63	2,79
Tliq= 45/113	-10	14	291,1	994	250,5	2,31	7,88	1,99	126,1	0,67	3,48
[°C / °F]	-35	-31	60,4	206	52,0	1,05	3,57	0,90	57,7	0,41	0,79
cond. pressure	-30	-22	95,2	325	81,9	1,17	4,00	1,01	81,3	0,50	1,24
pc= 55/131	-25	-13	130,1	444	112,0	1,31	4,48	1,13	99,2	0,57	1,70
return gas temp	-23	-10	142,4	486	122,6	1,37	4,66	1,18	104,3	0,59	1,86
RGT= 32/90	-20	-4	167,3	571	144,0	1,48	5,04	1,27	113,3	0,62	2,19
liquid temp	-15	5	208,5	712	179,5	1,66	5,68	1,43	125,4	0,67	2,73
Tliq= 55/131	-10	14	255,8	874	220,2	1,86	6,36	1,60	137,3	0,72	3,36

Model

Designation **HXK95AT** **220-240V/50Hz** Conf. 3 Sales code: **16438100**

Configuration

Motor configuration RSCR
 Power supply (nominal) 220-240V/50Hz 1~
 Refrigerant R600a
 Application LBP
 Voltage range 170-264V
 Starting torque LST
 Approvals VDE

Electrical accessories / wiring diagram

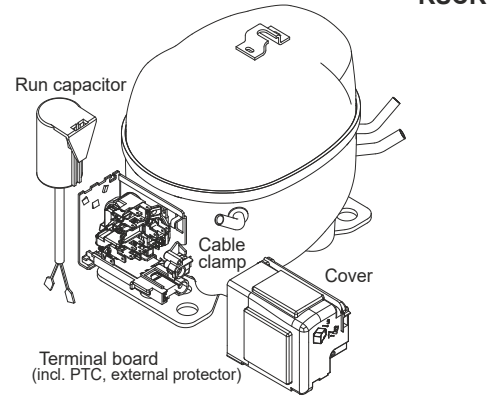

Ambient/ machine room temperatures minimum /maximum

Ambient temperature range: 10 - 43°C / 50 - 110°F
 Machine room temperature range: 10 - 48°C / 50 - 119°F
 Compressor cooling: static

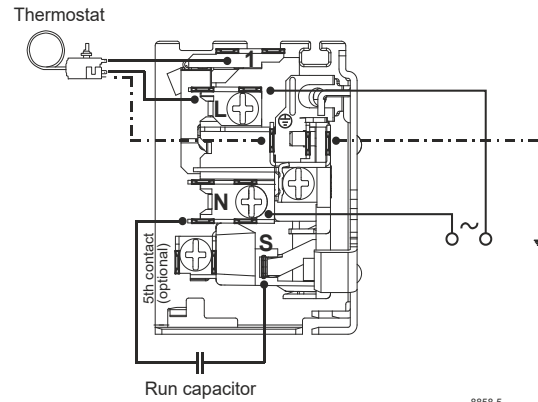

Operation pressure range

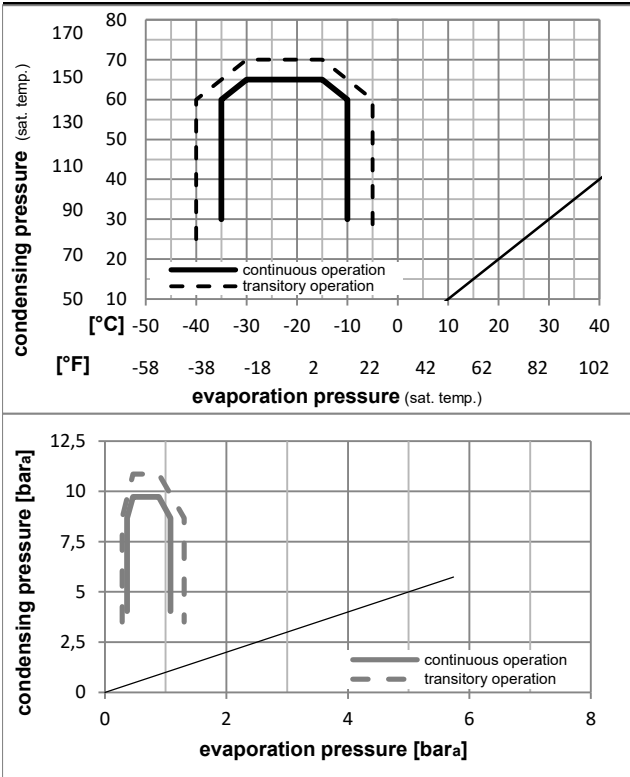

Components

- . terminal board (PTC, 4.8mm) 16403800
- . run capacitor (4μF, 4.8mm) 11261700
- b cover terminal board 10636401
- . cable clamp 16058100
- . screw - uni6954 10636000
- . screw - uni6954 10636200

Alternative components

- . screw uni en iso 4757 10641201

Model

Designation **HXK95AT** **220-240V/50Hz** Conf. 3 Sales code: **16438100**

Optimization + standard conditions

R600a, 230V/50Hz, RSCR, static, VDE

		Evaporating pressure (saturation temperature)				Condensing pressure (saturation temperature)			Return gas temp.		Liquid temp.		Cooling capacity			COP	EER	Power consumption		
		pe	pc	RGT	Tliq	[W]	[Btu/h]	[kcal/h]	[W/W]	[Btu/Wh]	[kcal/Wh]	[W]	I	m				[W]	[A]	[kg/h]
[°C]	-23	54	32	32	173,4	592	149,2	1,68	5,73	1,44	103,4	0,58	1,86	ASHRAE LBP						
[°F]	-10	130	90	90																
[°C]	-25	55	32	55	130,1	444	112,0	1,32	4,51	1,14	98,6	0,56	1,70	cecomaf LBP						
[°F]	-13	131	90	131																
[°C]	-35	40	20	40	93,8	320	80,8	1,39	4,75	1,20	67,4	0,45	1,14	EN12900 LBP						
[°F]	-31	104	68	104																
[°C]	-23	49	4,4	49	139,8	477	120,3	1,39	4,74	1,20	100,6	0,57	2,04	ARI540 LBP						
[°F]	-10	120	40	120																
[°C]	-23	41	32	32	179,1	612	154,1	1,87	6,40	1,61	95,5	0,55	1,92	AHAM LBP						
[°F]	-10	105	90	90																
[°C]	-35	45	32	45	89,2	305	76,7	1,36	4,65	1,17	65,5	0,44	1,06	opt						
[°F]	-31	113	90	113																

Performance tables

R600a, 230V/50Hz, RSCR, static, VDE

	pe		Cooling capacity			COP	EER		P1	I	m
	[°C]	[°F]	[W]	[Btu/h]	[kcal/h]	[W/W]	[Btu/Wh]	[kcal/Wh]	[W]	[A]	[kg/h]
[°C / °F]	-35	-31	89,2	305	76,7	1,36	4,65	1,17	65,5	0,44	1,06
cond. pressure	-30	-22	116,6	398	100,4	1,42	4,85	1,22	82,2	0,50	1,39
pc= 45/113	-25	-13	148,6	507	127,9	1,57	5,36	1,35	94,7	0,55	1,77
return gas temp.	-23	-10	160,8	549	138,4	1,64	5,59	1,41	98,3	0,56	1,92
RGT= 32/90	-20	-4	187,0	639	161,0	1,78	6,09	1,54	104,8	0,59	2,23
liquid temp	-15	5	233,9	799	201,3	2,04	6,98	1,76	114,4	0,63	2,79
Tliq= 45/113	-10	14	291,1	994	250,5	2,32	7,93	2,00	125,4	0,67	3,48
[°C / °F]	-35	-31	60,4	206	52,0	1,05	3,60	0,91	57,4	0,41	0,79
cond. pressure	-30	-22	95,2	325	81,9	1,18	4,02	1,01	80,8	0,49	1,24
pc= 55/131	-25	-13	130,1	444	112,0	1,32	4,51	1,14	98,6	0,56	1,70
return gas temp	-23	-10	142,4	486	122,6	1,37	4,69	1,18	103,7	0,58	1,86
RGT= 32/90	-20	-4	167,3	571	144,0	1,49	5,07	1,28	112,6	0,62	2,19
liquid temp	-15	5	208,5	712	179,5	1,67	5,71	1,44	124,6	0,67	2,73
Tliq= 55/131	-10	14	255,8	874	220,2	1,87	6,40	1,61	136,5	0,72	3,36

Model

Designation **HXK95AT** **208-230V/60Hz** Conf. 4 Sales code: **16438100**

Configuration

Motor configuration RSCR
 Power supply (nominal) 208-230V/60Hz 1~
 Refrigerant R600a
 Application LBP
 Voltage range 198-253V
 Starting torque LST
 Approvals VDE

Electrical accessories / wiring diagram

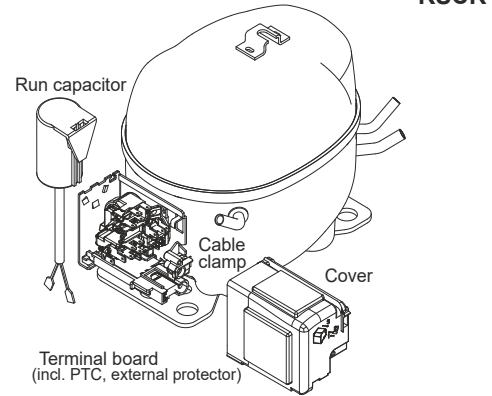

Ambient/ machine room temperatures minimum /maximum

Ambient temperature range: 10 - 43°C / 50 - 110°F
 Machine room temperature range: 10 - 48°C / 50 - 119°F
 Compressor cooling: static

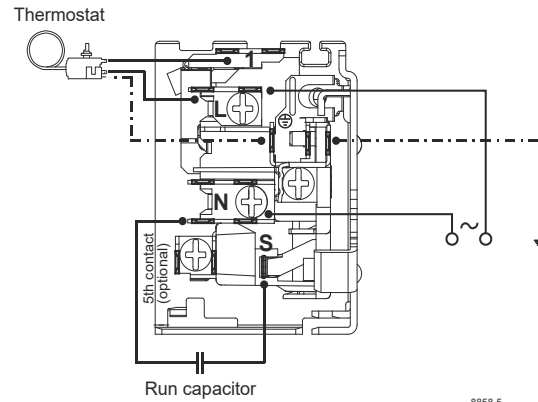

Operation pressure range

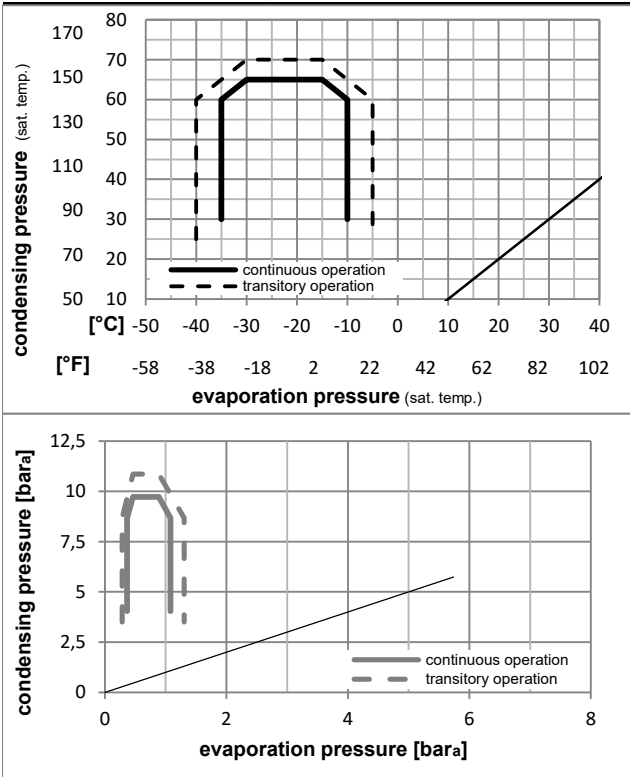

Components

- . terminal board (PTC, 4.8mm) 16403800
- . run capacitor (4μF, 4.8mm) 11261700
- b cover terminal board 10636401
- . cable clamp 16058100
- . screw - uni6954 10636000
- . screw - uni6954 10636200

Alternative components

- . screw uni en iso 4757 10641201

Model

Designation **HXK95AT** **208-230V/60Hz** Conf. 4 Sales code: **16438100**

Optimization + standard conditions

R600a, 220V/60Hz, RSCR, static, VDE

	Evaporating pressure (saturation temperature)				Condensing pressure (saturation temperature)			COP	EER	Power consumption			ASHRAE LBP	
	pe	pc	RGT	Tliq	[W]	[Btu/h]	[kcal/h]			P1	I	m		
	[°C]	[°F]	[°C]	[°F]	[W]	[Btu/h]	[kcal/h]	[W/W]	[Btu/Wh]	[kcal/Wh]	[W]	[A]	[kg/h]	
	-23	54	32	32	200,6	685	172,7	1,77	6,04	1,52	113,5	0,59	2,15	ASHRAE LBP
	-10	130	90	90										
	-25	55	32	55	151,3	517	130,3	1,39	4,73	1,19	109,2	0,56	1,97	cecomaf LBP
	-13	131	90	131										
	-35	40	20	40	115,8	396	99,7	1,36	4,66	1,17	84,9	0,40	1,41	EN12900 LBP
	-31	104	68	104										
	-23	49	4,4	49	161,0	550	138,5	1,46	4,98	1,26	110,4	0,58	2,35	ARI540 LBP
	-10	120	40	120										
	-23	41	32	32	206,5	705	177,7	1,97	6,73	1,69	104,9	0,56	2,22	AHAM LBP
	-10	105	90	90										
	-35	45	32	45	113,7	388	97,9	1,31	4,49	1,13	86,5	0,38	1,35	opt
	-31	113	90	113										

Performance tables

R600a, 220V/60Hz, RSCR, static, VDE

	pe		Cooling capacity			COP	EER		P1	I	m
	[°C]	[°F]	[W]	[Btu/h]	[kcal/h]	[W/W]	[Btu/Wh]	[kcal/Wh]	[W]	[A]	[kg/h]
[°C / °F]	-35	-31	113,7	388	97,9	1,31	4,49	1,13	86,5	0,38	1,35
cond. pressure	-30	-22	135,6	463	116,7	1,44	4,92	1,24	94,1	0,47	1,61
pc= 45/113	-25	-13	170,3	582	146,6	1,64	5,59	1,41	104,1	0,55	2,03
return gas temp.	-23	-10	184,9	632	159,1	1,71	5,85	1,47	107,9	0,57	2,20
RGT= 32/90	-20	-4	217,0	741	186,7	1,87	6,40	1,61	115,8	0,60	2,59
liquid temp	-15	5	274,5	938	236,3	2,13	7,29	1,84	128,6	0,65	3,28
Tliq= 45/113	-10	14	342,1	1168	294,4	2,41	8,23	2,07	142,0	0,71	4,10
[°C / °F]	-35	-31	95,3	326	82,0	1,10	3,76	0,95	86,6	0,32	1,24
cond. pressure	-30	-22	118,1	403	101,7	1,22	4,17	1,05	96,8	0,46	1,54
pc= 55/131	-25	-13	151,3	517	130,3	1,39	4,73	1,19	109,2	0,56	1,97
return gas temp	-23	-10	164,8	563	141,9	1,45	4,94	1,25	113,8	0,59	2,15
RGT= 32/90	-20	-4	194,0	663	167,0	1,57	5,38	1,36	123,2	0,64	2,54
liquid temp	-15	5	245,2	837	211,0	1,77	6,06	1,53	138,2	0,70	3,21
Tliq= 55/131	-10	14	303,9	1038	261,6	1,98	6,76	1,70	153,4	0,77	3,99

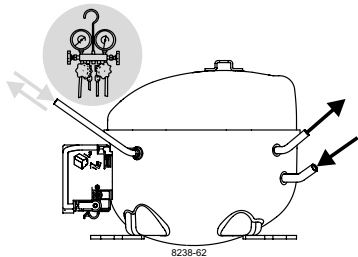

K-Series Compressors

GTK, HKK, HMK, HTK, HXK, HZK

SECCP

Keep electrical equipment clear from oil, chemicals, and water.



When operated with a flammable refrigerant, only spark-proof starting equipment is allowed.

RSCR

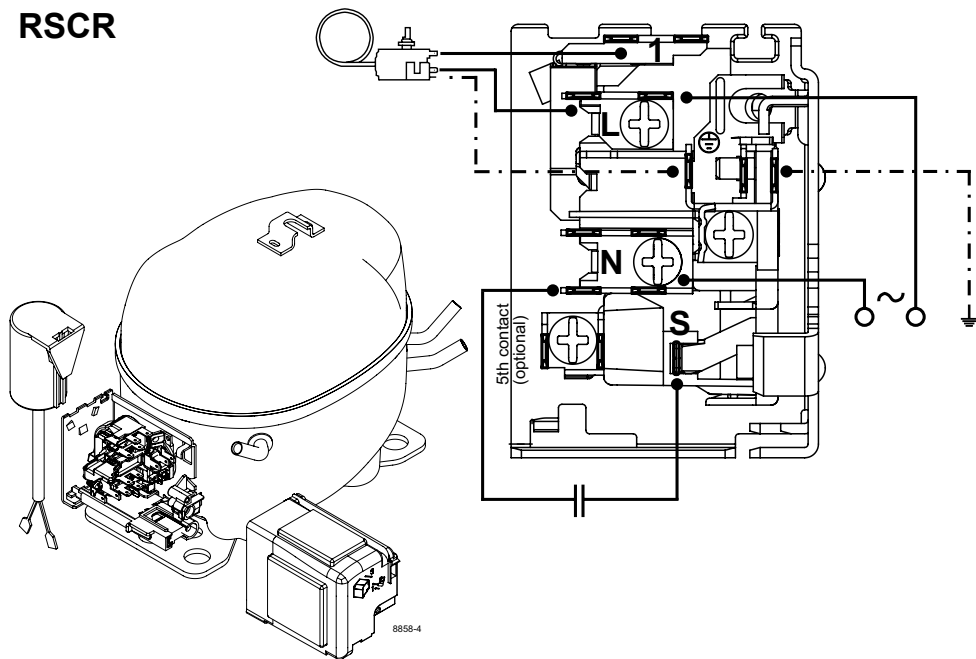

Service/Repair – R600a, R1234yf
(applies to all flammable refrigerants)

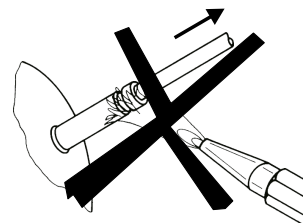

8545-2

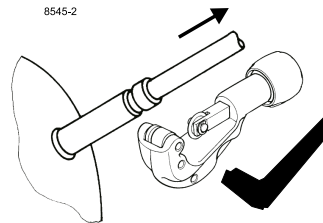

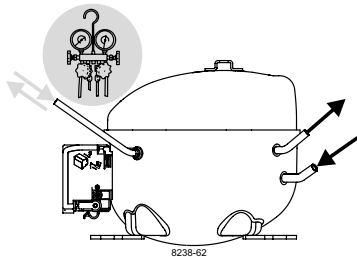

K-Series Compressors

GTK, HKK, HMK, HTK, HXK, HZK



Keep electrical equipment clear from oil, chemicals, and water



When operated with a flammable refrigerant, only spark-proof starting equipment is allowed.

RSIR

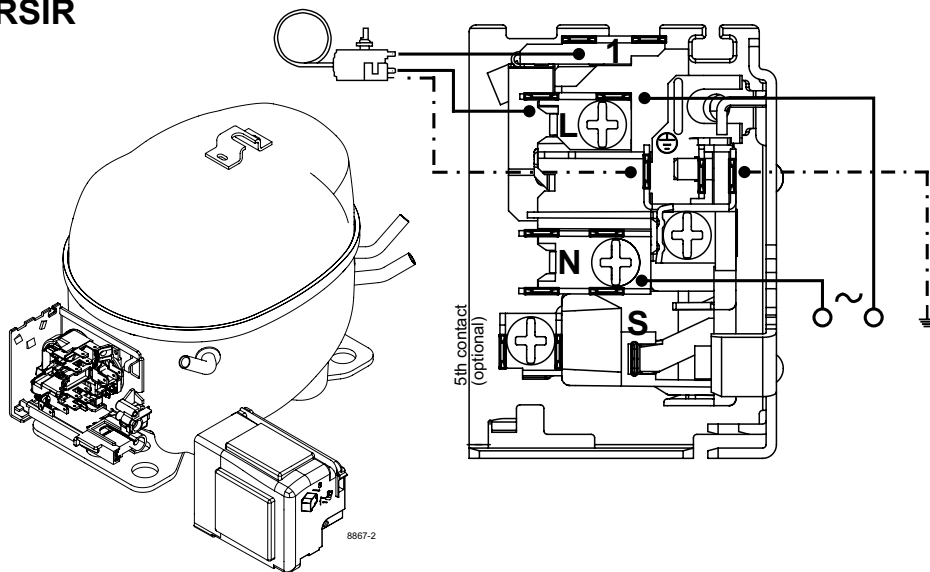

Service/Repair – R600a, R1234yf (applies to all flammable refrigerants)

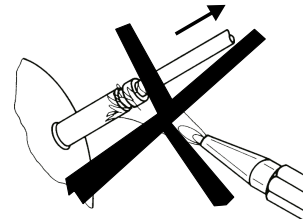

8545-2

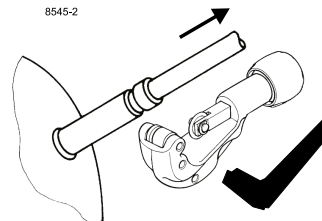

Dismantling, recycling, disposal: At the end of a compressor's lifecycle, proceed by separating and storing components according to their environmental impact. Parts that may cause pollution must be clearly identified and handled separately, ensuring appropriate disposal. Refrigerant gas must not be released into the environment and should be recovered by qualified operators. Compressor oil must also be collected separately. The compressor should be disposed of at specialized disposal centers in accordance with the applicable regulations. **Subject to modifications/alterations. www.seccop.com**